

SIMPLY BETTER.

Ideal clamping tools for metalworking.

(April 2024)



BESSEY's unrivalled all-steel quality



Original BESSEY all-steel screw clamp GZ with 2-component plastic handle



Order number	Opening	Throat depth	Rail	Weight	PU	V2
	mm	mm	mm	kg	qty.	
GZ10-2K	100	60	15 x 6	0.31	10	
GZ12-2K	120	60	15 x 6	0.32	10	
GZ16-2K	160	80	17.5 x 6.8	0.57	10	
GZ40-8-2K	400	80	17.5 x 6.8	0.76	10	
GZ20-2K	200	100	22 x 8.5	1.01	10	
GZ25-2K	250	120	24.5 x 9.5	1.38	10	
GZ30-12-2K	300	120	24.5 x 9.5	1.46	10	
GZ40-12-2K	400	120	24.5 x 9.5	1.62	10	
GZ50-12-2K	500	120	24.5 x 9.5	1.78	10	
GZ60-12-2K	600	120	24.5 x 9.5	1.95	5	
GZ80-12-2K	800	120	24.5 x 9.5	2.20	5	
GZ100-12-2K	1000	120	24.5 x 9.5	2.45	5	
GZ30-2K	300	140	28 x 11	1.98	10	
GZ40-2K	400	120	28 x 11	2.12	10	
GZ50-2K	500	120	28 x 11	2.30	5	
GZ60-2K	600	120	28 x 11	2.49	5	
GZ80-2K	800	120	28 x 11	2.36	5	
GZ100-2K	1000	120	28 x 11	3.25	5	
GZ125-2K	1250	120	28 x 11	3.79	1	

- 20 % more clamping force per spindle rotation with optimised rail profile
- Maximum security with linear transfer of force at the sliding arm
- Clamping force up to 6,000 N
- Fixed jaw and sliding arm are constructed of tempered steel for resilient clamping
- High-quality 2-component plastic handle
- Pressure plates can be replaced by hand – no need for tools (from 80 mm width)

Lever clamp GH



Order number	Opening	Throat depth	Rail	Weight	PU	V2
	mm	mm	mm	kg	qty.	
GH12	120	60	15 x 6	0.49	10	
GH16	160	80	17.5 x 6.8	0.64	10	
GH20-8	200	80	17.5 x 6.8	0.68	10	
GH20	200	100	22 x 8.5	1.11	10	
GH25	250	120	24.5 x 9.5	1.44	10	
GH30-12	300	120	24.5 x 9.5	1.51	10	
GH40-12	400	120	24.5 x 9.5	1.67	10	
GH30	300	140	28 x 11	2.22	10	
GH40	400	120	28 x 11	2.39	10	
GH50	500	120	28 x 11	2.61	5	
GH60	600	120	28 x 11	2.78	5	
GH80	800	120	28 x 11	3.14	5	
GH100	1000	120	28 x 11	3.57	5	

- Greater reserves of power, thanks to optimised rail profile, for even clamping force build-up, especially under maximum utilisation of the clamping range
- Non-slip trigger release
- Sintered steel cams – particularly hard-wearing, low friction due to higher surface hardness
- Quick – up to 5 x faster than regular clamps
- Secure – vibration resistant
- Strong – clamping force up to 8,500 N

Range summary



Optimised rail profile – clamping force up to 6,000 N

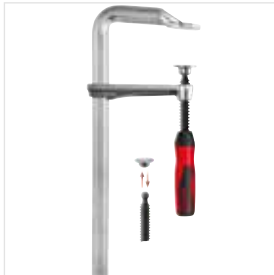

All-steel screw clamp with 2K plastic handle GZ-2K

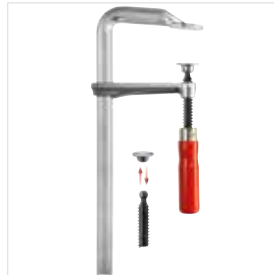

All-steel screw clamp with wooden handle GZ

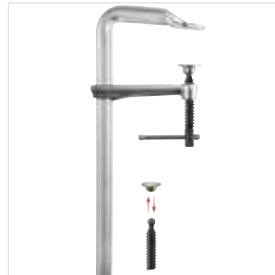

All-steel screw clamp with tommy bar GZ-K

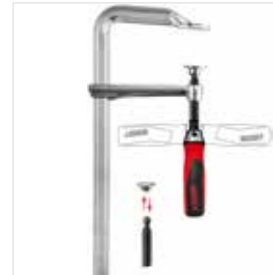

All-steel screw clamp with swivel handle GZ-KG

www.bessey.de

Detailed information about all all-steel screw clamps at www.bessey.de/en-gb

Patented OMEGA bend – clamping force up to 5,000 N

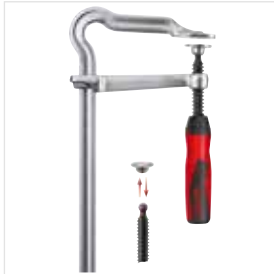

OMEGA screw clamp with 2K plastic handle GMZ-2K



OMEGA screw clamp with tommy bar GMZ-K

Multi angle pad VAD (2 pcs./bag)



Order-number	Angle	Jaw face width	Weight	PU	V3
		mm	kg	qty.	
VAD	from 60° inner to 60° outer	45	0.48	48	

- For adaptation to round, oval and angular workpieces in particular
- Infinite angle adjustment from 60° inner to 60° outer
- Suitable for original BESSEY GZ and GMZ from 100 mm throat depth and for clamping elements for welding tables TWV and TW

Rapid, secure and strong – clamping force up to 9,500 N



Lever clamp GH

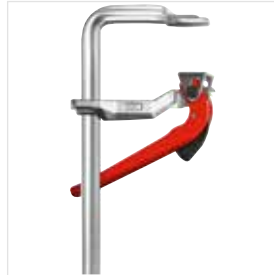

Lever clamp with reversed clamping lever SGHS



Lever clamp classIX GSH



All-steel screw clamp with wooden handle classIX GS



All-steel screw clamp with tommy bar classIX GS-K

Tried-and-true rail profile – clamping force up to 5,000 N

High-performance clamping



High-performance clamp SGM

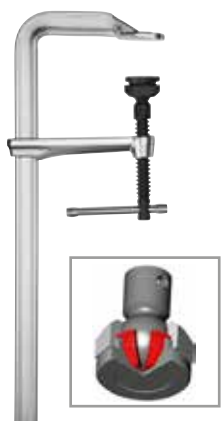

Order number	Opening	Throat depth	Rail	Weight	PU	V2
	mm	mm	mm	kg	qty.	
SG25M	250	140	34 x 13	2.58	5	
SG30M	300	140	34 x 13	3.03	5	
SG40M	400	140	34 x 13	3.17	5	
SG50M	500	140	34 x 13	3.40	5	
SG60M	600	140	34 x 13	3.80	5	
SG80M	800	140	34 x 13	4.45	5	
SG100M	1000	140	34 x 13	4.95	5	
SG125M	1250	140	34 x 13	5.87	1	
SG150M	1500	140	34 x 13	6.63	1	

- Clamping force up to 12,000 N at tightening torque of 40 Nm
- 20 % more clamping force per spindle rotation with optimised rail profile
- Maximum safety due to the better linear transfer of force of the sliding arm
- Long life due to heat-resistant pressure plate with sintered steel insert, which can be tilted up to 35°

Suitable pressure plates see on page 18

High-performance clamp STBM



Order number	Opening	Throat depth	Rail	Weight	PU	V2
	mm	mm	mm	kg	qty.	
STB30M	300	175	40 x 20	5.61	1	
STB40M	400	175	40 x 20	6.10	1	
STB50M	500	175	40 x 20	6.67	1	
STB60M	600	175	40 x 20	7.23	1	
STB80M	800	175	40 x 20	8.35	1	
STB100M	1000	175	40 x 20	9.32	1	
STB125M	1250	175	40 x 20	10.77	1	
STB150M	1500	175	40 x 20	12.20	1	

- Clamping force up to 22,000 N at tightening torque of 70 Nm
- Long life due to heat-resistant pressure plate with sintered steel insert, which can be tilted up to 35°
- With 19 mm hexagonal bolt on the end of the spindle

Suitable pressure plates see on page 18

Range summary

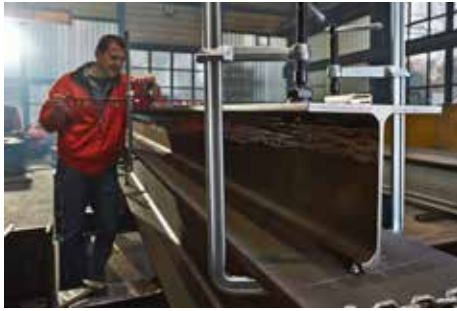
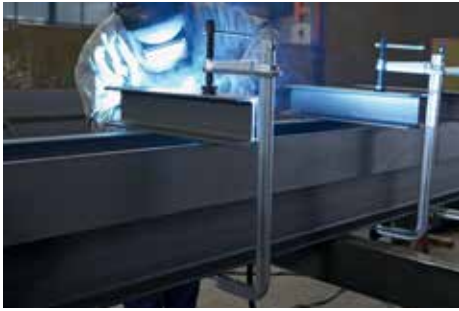

**Optimised rail profile – clamping force up to 12,000 N
heat-resistant pressure plate with sintered steel insert for long life**

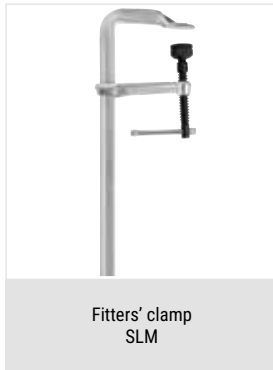

Detailed information about all
high-performance clamps at
www.bessey.de/en-gb

**Tried-and-true rail profile – clamping force up to 35,000 N
heat-resistant pressure plate with sintered steel insert for long life**

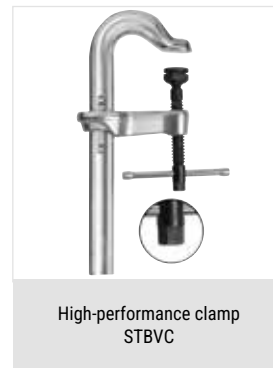

**Tried-and-true rail profile – clamping force up to
11,000 N; heat-resistant pressure plate**

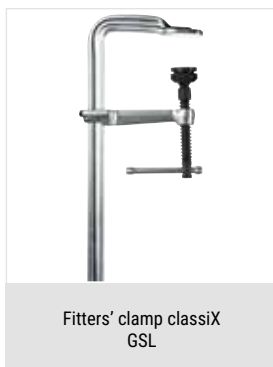

New flexibility with large clamping widths



Secure

- due to high clamping forces up to 6,500 N at SLV resp. 9,000 N at GSV
- due tipping is prevented through central positioning on the workpiece

Versatile

- In addition to classic clamping work, the clamp can also be used for spreading. It can be fed through an opening in the work-piece/component and add additional sliding arms easily.
- due to end fastenings on both sides which can be loosened without tools

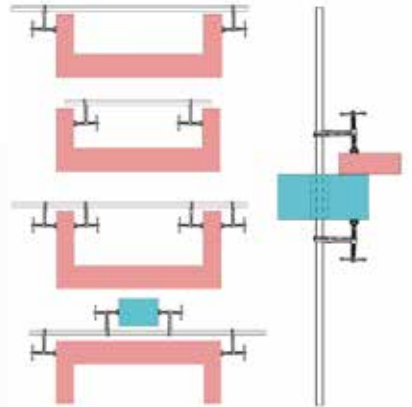

Durable

- due to the heat-resistant pressure plate, which can be tilted up to 35° – GSV has a hardened and oil-soaked sintered steel insert for outstanding sliding and emergency running properties
- due to a tempered spindle



Variable high-performance clamps – Complete sets SLV/GSV



Order number	Opening a	Throat depth b	Spreading width e	Rail	Weight	PU	V2
	mm	mm	mm	mm	kg	qty.	
Variable high-performance clamp set SLV							
SLV100M	1000	120	340-1250	27 x 13	4.71	1	
SLV150M	1500	120	340-1750	27 x 13	5.90	1	
SLV200M	2000	120	340-2250	27 x 13	6.50	1	
Variable high-performance clamp set GSV							
GSV300M	3000	140	400-3340	30 x 15	12.98	1	

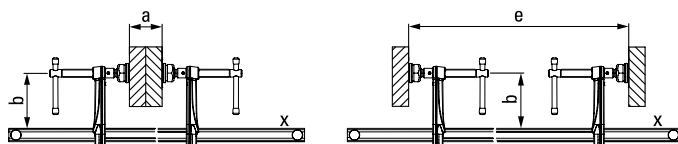

- Clamping force up to 6,500 N (SLV) or 9,000 N (GSV)
- Tipping is prevented through central positioning on the workpiece
- Special heat-resistant pressure plate, can be tilted by up to 35° – GSV with sintered steel insert
- Clamp can be fed through an opening in the workpiece/component
- Wide range of possible applications due to interchangeable sliding arm available in various different designs (see accessories)



**4 clamp sets
+ 4 rails
+ 6 sliding arms
= "X" options**

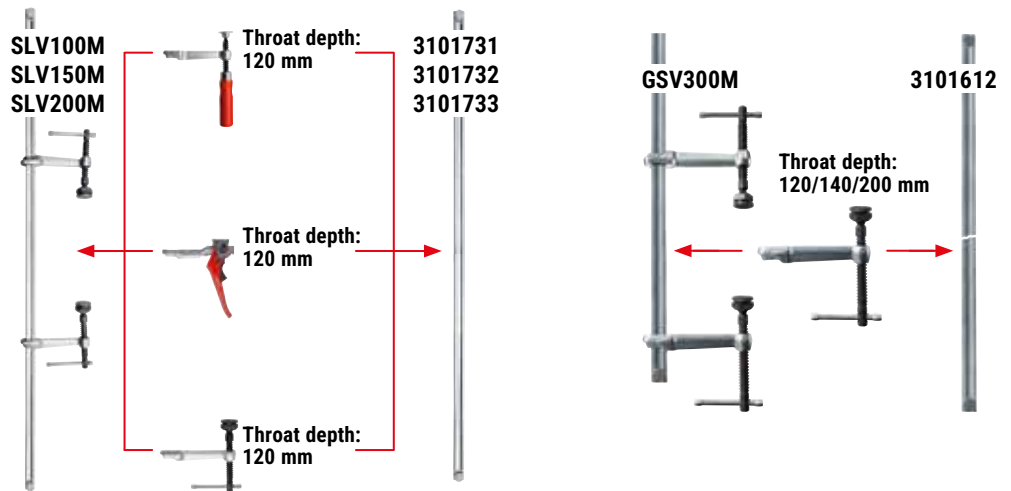

SLV/GSV size rails



Order number	Opening mm	Rail mm	Weight kg	PU qty.	V2
SLV size rail					
3101731	1000	27 x 13	2.85	1	
3101732	1500	27 x 13	4.05	1	
3101733	2000	27 x 13	5.25	1	
GSV size rail					
3101612	3000	30 x 15	10.40	1	

- 27 x 13 mm (SLV) or 30 x 15 mm (GSV) profile, cold drawn and galvanized
- End fastenings on both sides can be loosened without tools – for rapid changeover
- Suitable for all SLV or GSV size sliding arms

Complete sliding arm for SLV sizes



Order number	Description mm	Throat depth mm	Rail mm	Weight kg	PU qty.	V2
3101426	Wooden handle	120	27 x 13	0.73	1	
3101337	Lever handle	120	27 x 13	1.10	1	
3101338	Tommy bar incl. special pressure plate	120	27 x 13	0.82	1	

- Three different grip variants/designs
- Suitable for all SLV size rails

Complete sliding arm for GSV sizes



Order number	Description mm	Throat depth mm	Rail mm	Weight kg	PU qty.	V3
3101329	Tommy bar incl. special pressure plate	120	30 x 15	1,13	1	
3101330	special pressure plate	140	30 x 15	1,23	1	
3101331	with sintered steel insert	200	30 x 15	1,40	1	

- One arm design with three throat depths
- Suitable for GSV size rails

Step-over clamping

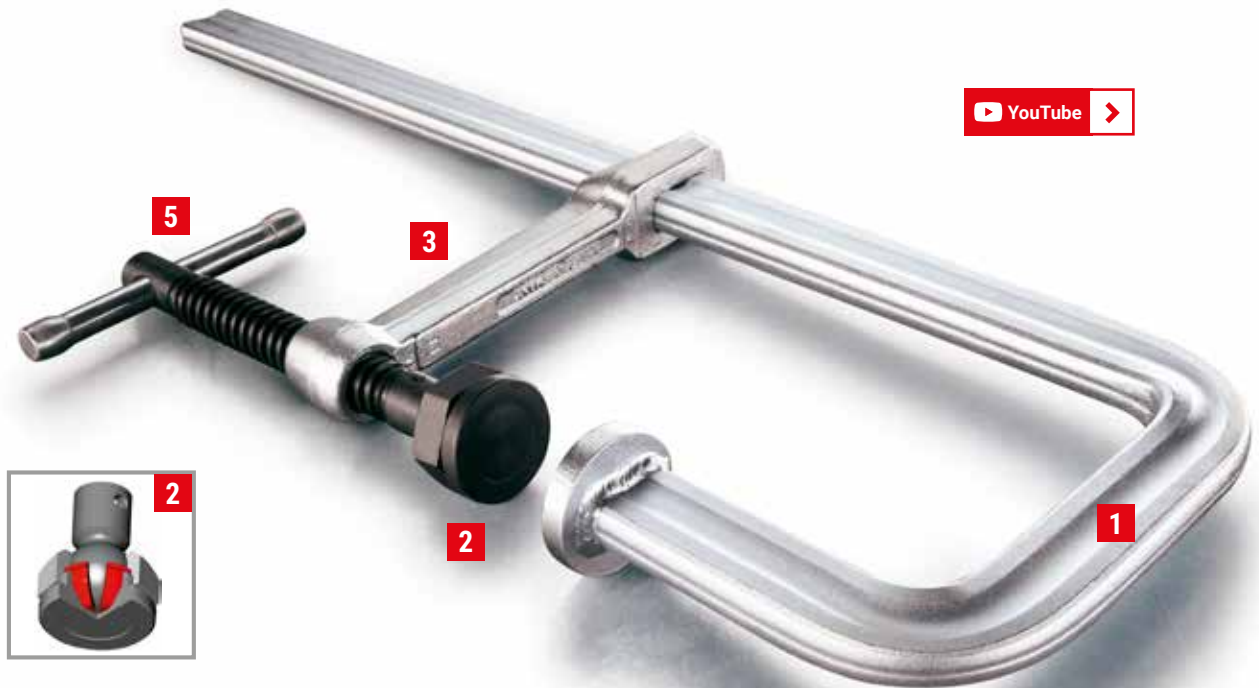

Your benefits at a glance:

1 Extremely sturdy

The U-shaped fixed arm is produced and tempered from a single piece, thus very torsion-resistant. This guarantees you maximum tensile strength and sturdiness.

2 Special tilting pressure plate

The heat-resistant pressure plate (SGU/STBU) is replaceable and can be tilted up to 35° so it can even clamp on angled or sloping surfaces. It has an extremely long service-life due to the oil-soaked sintered steel insert's excellent sliding and emergency running properties.

3 Forged sliding arm

The sliding arm is made from forged tempered steel, and can withstand extremely large loads. You can be sure of that.

4 Tempered spindle

The tempered spindle is particularly sturdy and wear-resistant. This considerably increases its durability.

5 Sturdy tommy bar

The sturdy tommy bar has special rounded hand-friendly ends, as well as a hexagonal bolt. This allows powerful, controlled clamping.



U-shaped all-steel screw clamp GUZ



Order number	a	b	c	d	Rail	Weight	PU	
	mm	mm	mm	mm	mm	kg	qty.	V2
GU25-12-6ZK	250	120	60	60	22 x 10.5	1.46	10	

- Clamping force up to 4,000 N
- Double-sided step-over clamping, specially suited for T-profiles and double T-profiles
- Low weight
- Tempered stainless steel and fixed bracket for resilient and elastic clamping

U-shaped high-performance clamp SGU



Order number	a	b	c	d	Rail	Weight	PU	
	mm	mm	mm	mm	mm	kg	qty.	V2
SGU30-14-10	300	140	100	130	30 x 15	3.75	5	

Suitable pressure plates see on page 18

- Clamping force up to 12,000 N at tightening torque of 40 Nm
- Double-sided step-over clamping, specially suited for T-profiles and double T-profiles
- Long life due to heat-resistant pressure plate with sintered steel insert, which can be tilted up to 35°

U-shaped high-performance clamp STBU



Order number	a	b	c	d	Rail	Weight	PU	
	mm	mm	mm	mm	mm	kg	qty.	V2
STBU40-17-15	500	175	150	110	40 x 20	7.96	1	

Suitable pressure plates see on page 18

- Clamping force up to 22,000 N at tightening torque of 80 Nm
- Double-sided step-over clamping, specially suited for T-profiles and double T-profiles
- With 19 mm hexagonal bolt on the end of the spindle
- Long life due to heat-resistant pressure plate with sintered steel insert, which can be tilted up to 35°

U-shaped lever clamp GUH



Order number	a	b	c	d	Rail	Weight	PU	
	mm	mm	mm	mm	mm	kg	qty.	V2
GU25-12-6H	250	120	60	10	22 x 10.5	1.67	5	

- Clamping force up to 3,800 N
- Step-over clamping, specially-suited for T profiles
- Low weight
- Quick – up to 5 x faster than regular clamps

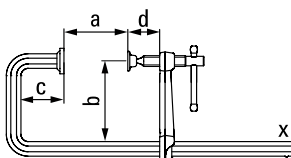

Extremely variable clamping



Your benefits at a glance:

- 1 Multi-angle pad**
The multi-angle pad is especially adapted to round, oval and angled workpieces – from 60° inside to 60° outside. For perfectly flat clamping remove the multi-angle pad. For spreading it is easy to reverse the position of the pad on the anvil of the clamp. Its like having 3 clamps in one.
- 2 Removable end stop**
The end stop can be removed – to allow the sliding arm to be quickly turned around for spreading
- 3 Pressure plate**
For enhanced serviceability the pressure plate can be changed with no need for tools. It can be replaced very easily and quickly.
- 4 Tommy bar with BESSEY grip**
The addition of the plastic BESSEY grip means that clamping can also be very comfortable. The stable tommy bar has a plastic pad to ensure that it is easy to grip with your hand. This allows powerful, controlled clamping.

KombiKlamp SG-VAD



Order number	Opening	Throat depth	Rail	Weight	PU	
	mm	mm	mm	kg	qty.	V2
SG30VAD	300	120	30 x 15	2.95	6	



- Clamping force up to 7,500 N
- Clamping and spreading of round, oval and angled workpieces
- Pressure plates can be replaced with no need for tools

Clamping and spreading in confined spaces



Your benefits at a glance:

- 1 Maximum stability**
The clamp forged from a single piece with moulded pressure plate is hardened, tempered and galvanised, making it highly durable and torsion-resistant. The optimised profile now allows greater extension with the same stability.
- 2 External handle**
The handle is located behind the clamp's rail. This is specially conceived to allow the clamping and spreading of work-pieces which are not easily accessible.
- 3 Special V-grooved pressure plate**
This sturdy pressure plate is made from high-grade cast iron, and can be tilted by up to 30°. The prism is ideal for clamping and spreading round or angular work-pieces.
- 4 Removable end stop**
The end stop can be removed – to allow the sliding arm to be quickly turned around for spreading.

Claw clamp GRA



Order number	Opening	Throat depth	Rail	Weight	PU	V2
	mm	mm	mm	kg	qty.	
GRA30-12	300	120	28 x 11	2.41	5	
GRA60-12	600	120	28 x 11	3.02	5	
GRA100-12	1000	120	28 x 11	3.80	5	

- Clamping and spreading force up to 7,500 N
- Externally-positioned spindle, protected from welding spatter
- Clear access to work area

Pressure piece GRD (2 pcs./bag)



Order number	Weight	PU	V2
	kg	qty.	
GRD	0.61	10	

- Spreading from the inside outwards
- Flat jaw face
- V-groove for clamping round and oval workpieces

Clamping angles and mitres

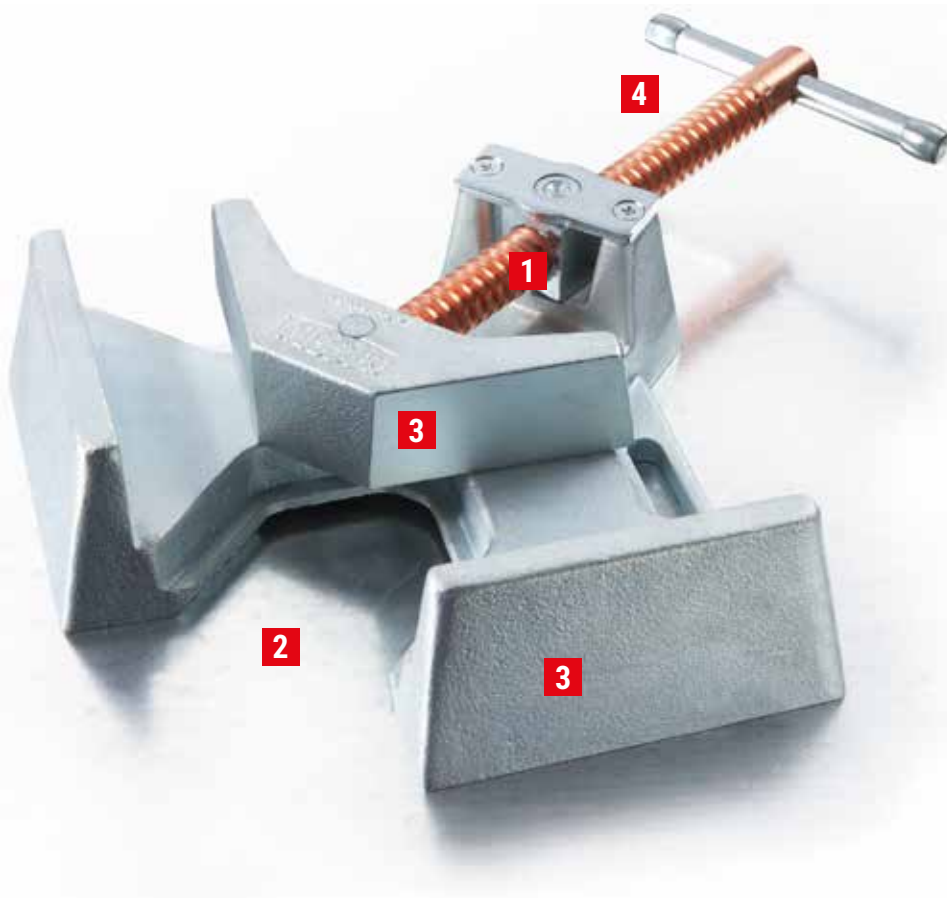

Your benefits at a glance:

- 1 Automatic adjustment**
The spindle nut with articulated bearing allows automatic adjustment of the pressure jaws for different workpiece.
- 2 Open working area**
The open passage makes it possible to fix T-fasteners and ensures free access to the workpiece for welding and assembly work.
- 3 Stable base and clamping jaws**
The stable base and the clamping jaws are manufactured from high-quality cast iron for high clamping power. They are zinc-coated and thus protected against corrosion. The jaws are processed for precise right-angled clamping.
- 4 Copper-plated spindle**
The spindle with acme thread is copperplated to prevent the adhesion of welding spatter.

Welders' angle clamps WSM



Order number	Opening	Current passage m	Jaw height	Weight	PU	
	mm	mm	mm	kg	qty.	V3
WSM9	2 x 90	60	35	3.58	1	
WSM12	2 x 120	100	61	7.35	1	

3D CAD data in the download area of the BESSEY website

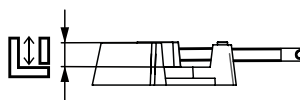
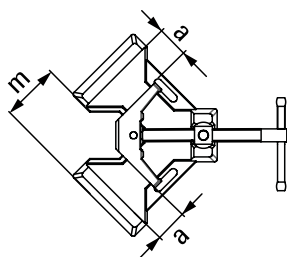

- Automatic adjustment to workpieces of various thicknesses
- Sturdy jaws and base plate made from high-quality cast iron
- The copper-plated spindle prevents welding splatter from sticking
- Precise 90°-angles



Clamping and gripping



Parallel grip GRZ

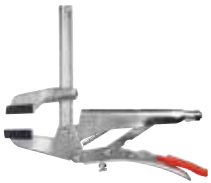

Order number	Opening	Throat depth	Weight	PU	V3
	mm	mm	kg	qty.	
GRZ10	100	65	1.00	10	
GRZ20	200	65	1.20	10	

- Parallel jaw faces
- Prism recess for small round parts
- Includes pressure caps for gentle clamping of sensitive surfaces



C-grip GRZC

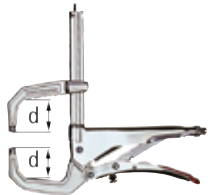

Order number	Opening	Throat depth	Clamping depth d	Weight	PU	V3
	mm	mm	mm	kg	qty.	
GRZC	110	80	40	1.10	10	

- For step-over clamping from both sides

Pipe grip GRZRO



Order number	For pipes Ø	Throat depth	Weight	PU	V3
	mm	mm	kg	qty.	
GRZRO	0-110	65	1.30	10	

- Ideal for holding round objects of constant diameter
- Includes pressure caps
- Gentle clamping of sensitive surfaces
- Suitable for tack welding, heat-resis-tant up to 200°C

Clamping using the original screw clamp shape



C-clamp VC



Order number	Opening		Throat depth		Rail	Clamping force kN	Weight kg	PU qty.	V2
	mm	"	mm	"					
VC2	0-50	0-2	50	2	19.5 x 9.5	7	0.43	10	
VC3	0-75	0-3	50	2	22 x 10.5	13	0.63	10	
VC4	0-100	0-4	60	2 3/8	25 x 12	13	1.02	10	
VC6	0-150	0-6	75	3	27 x 13	15	1.41	10	
VC8	0-200	0-7 7/8	90	3 1/2	30 x 15	15	2.25	5	
VC10	0-250	0-10	100	4	40 x 20	15	4.01	5	

- Clamping force of up to 15,000 N
- Nearly unbreakable and tempered
- Tried-and-true BESSEY all-steel quality

C-clamp SC



Order number	Opening		Throat depth		Clamping force kN	Weight kg	PU qty.	V2
	mm	"	mm	"				
SC40	0-40	0 - 1 5/8	40	1 5/8	5.5	0.36	10	
SC60	0-60	0 - 2 3/8	55	2 3/8	5.5	0.57	10	
SC80	0-80	0 - 3 1/8	65	2 9/16	10	0.99	10	
SC100	0-100	0 - 4	75	3	13.5	1.40	10	
SC120	0-120	0 - 7 7/8	85	3 1/4	18	2.10	10	
SC150	0-150	0 - 6	95	3 3/4	18	2.35	10	
SC200	0-200	0 - 7 7/8	105	4 1/4	22	4.00	5	

- Clamping force of up to 22,000 N
- Drop forged

C-clamp CDF-C



Order number	Opening		Throat depth		Clamping force kN	Weight kg	PU qty.	V2
	mm	"	mm	"				
CDF403C	0-75	0 - 3	60	2 3/8	13	0.85	6	
CDF404C	0-105	0 - 4 1/4	85	2 3/4	16.5	1.50	6	
CDF406C	0-150	0 - 6	100	3 5/8	17	2.32	6	
CDF408C	0-205	0 - 8	125	4 1/2	17	3.42	6	
CDF410C	50-245	2 - 10	150	5 3/8	18	5.30	4	

- Clamping force up to 18,000 N
- Drop forged, extremely stable
- The copper-plated spindle prevents welding splatter from sticking

For more safety when welding



Earth (ground) clamp LP / TP with tried-and true wooden handle



Order number	Opening	Throat depth	Rail	Hole Ø	Strength current max.	Weight	PU	
	mm	mm	mm	mm	A	kg	qty.	V1
LP-1	150	60	20 x 5	10.5	300	0.50	10	
TP-1	150	80	25 x 6	10.5	400	0.76	10	

- With malleable cast iron arms
- Ergonomically shaped wood handle
- Grounding connection hole in the upper part

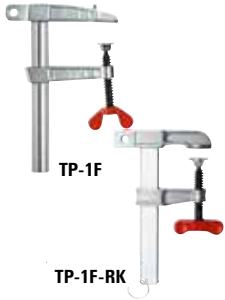

Earth (ground) clamp LP / TP with thumb screw



Order number	Opening	Throat depth	Rail	Hole Ø	Strength current max.	Weight	PU	
	mm	mm	mm	mm	A	kg	qty.	V1
LP-1F	150	60	20 x 5	10.5	300	0.53	10	
TP-1F	150	80	25 x 6	10.5	400	0.76	10	
TP-2F	150	60	30 x 8	11	600	1.12	20	
TP-1F-RK	150	80	25 x 6	10.5	400	0.78	10	
TP-2F-RK	150	60	30 x 8	11	600	1.12	20	

- With malleable cast iron arms
- Practical thumb screw
- Grounding connection hole in the upper part
- TP-...F-RK: Cable strain relief at rail end / ring internal diameter 30 mm



Earth (ground) clamp TP with tommy bar



Order number	Opening	Throat depth	Rail	Hole Ø	Strength current max.	Weight	PU	
	mm	mm	mm	mm	A	kg	qty.	V1
TP-1K	150	80	25 x 6	10.5	400	0.75	10	

- With malleable cast iron arms
- Tommy bar with rounded ends for simple transfer of force when clamping
- Grounding connection hole in the upper part



Earth (ground) clamp CP



Order number	Opening	Throat depth	Hole Ø	Strength current max.	Weight	PU	
	mm	mm	mm	A	kg	qty.	V1
CP-F	50	30	8,4	200	0,19	40	

- With C-shaped malleable cast iron arms

Clamp on welding tables

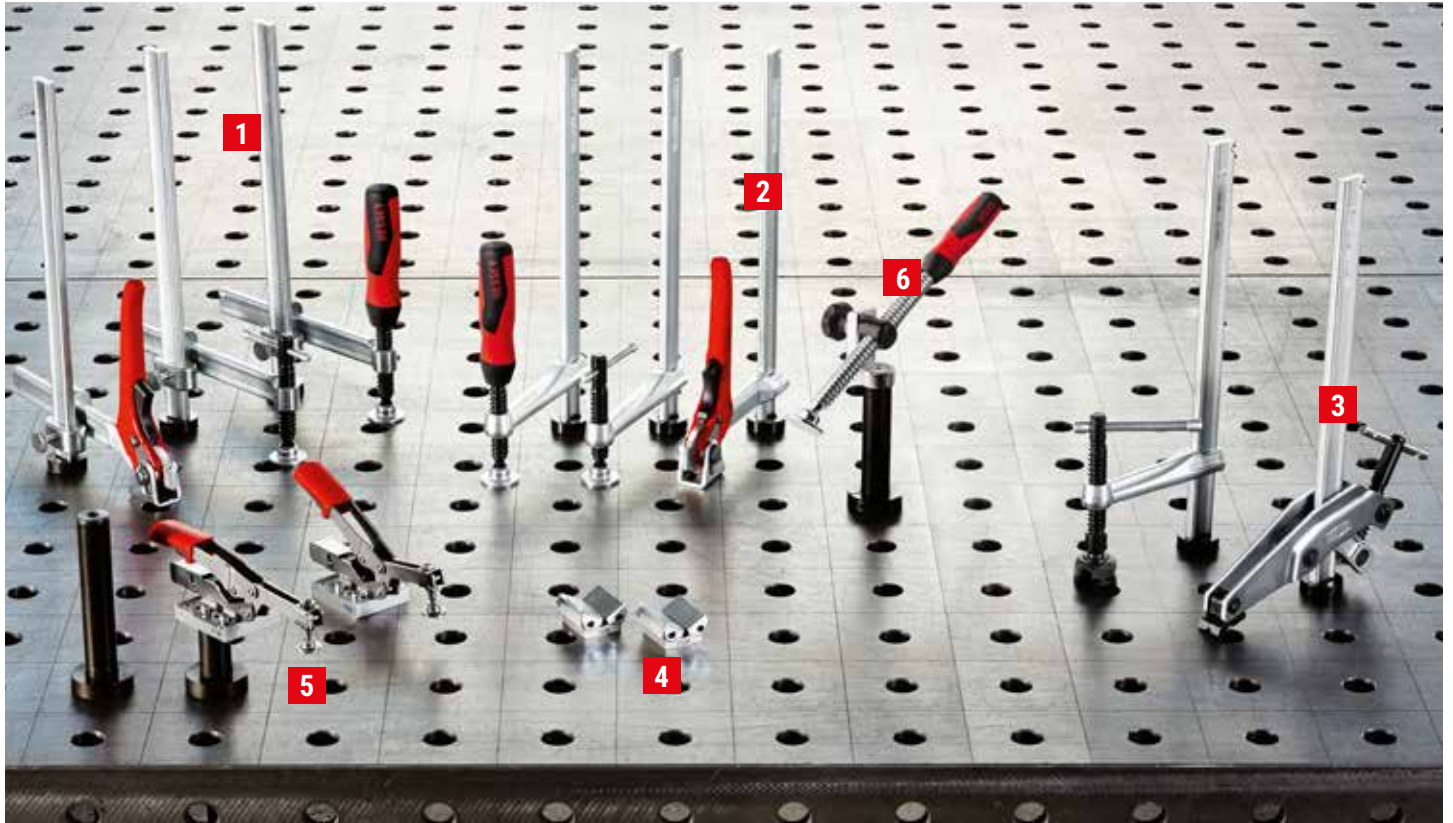

Your benefits at a glance:

1 Flexible throat depth

BESSEY TWV clamping elements for welding tables not only have infinitely adjustable throat depth, but are also available in three handle variants

2 100, 120 or 140 mm throat depth

On BESSEY TW clamping elements, you can choose among three handle variants and three throat-depth variants.

3 Heavy-duty, custom design

The TWM28 clamping element has a heat-resistant special pressure plate with sintered steel insert, which can be pivoted up to 35°. On the TW28GRS gripping arm variant the spindle is located on the outside, which enables – among other things – free access to the work area.

4 Perfect for railings

Whether the workpiece is round, oval or square, the TWWAD Vario table clamping attachments are ideally suited; this is because they can be infinitely adjusted to the workpiece being welded, from 60° internal to 60° external

5 Applying the quick clamp

Thanks to the TWA-STC adapter and the appropriate TWX extension, BESSEY toggle clamps with a horizontal base plate can also be rapidly applied to welding tables.

6 Diagonal und horizontal clamping

The tilting adaptor TW28AV used in conjunction with the extension TW28X allows angled or horizontal clamping in a range from -52 deg. to +52 deg.





Clamping element with variable throat depth TWV



Order number	Hole Ø	Opening	Throat depth	Rail	Weight	PU	
		mm	mm	mm	kg	qty.	V3
TWV16-20-15-2K	16	200	30-150	22 x 8.5	1.12	1	
TWV16-20-15K	16	200	30-150	22 x 8.5	1.04	1	
TWV16-20-15H	16	200	60-150	22 x 8.5	1.21	1	
TWV28-30-17-2K	28	300	40-175	28 x 11	2.22	1	
TWV28-30-17K	28	300	40-175	28 x 11	2.11	1	
TWV28-30-17H	28	300	110-175	28 x 11	2.48	1	

3D CAD data in the download area of the BESSEY website

- TWV16: Clamping force up to 2,500 N
TWV28: Clamping force up to 5,500 N
- TW16: Clamping force up to 3,000 N
TW28: Clamping force up to 5,000 N
- Precise, individual clamping
- Tempered profile and sliding arm for sprung and elastic clamping
- Infinitely adjustable throat depth (at TWV)

Various design versions:

- High quality 2-component plastic handle and tommy bar with rounded ends – each with smooth-running trapezoidal threaded spindle and tool-free pressure plate replacement
- Lever handle with an indexing mechanism for controlled, fast and vibration-proof clamping

Clamping element with fixed throat depth TW

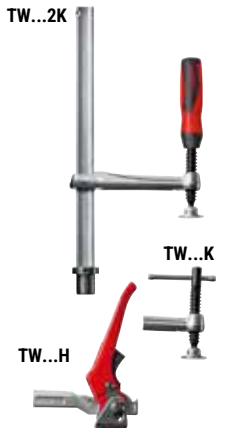

Order number	Hole Ø	Opening	Throat depth	Rail	Weight	PU	
		mm	mm	mm	kg	qty.	V3
TW16-20-10-2K	16	200	100	22 x 8.5	0.93	1	
TW16-20-10K	16	200	100	22 x 8.5	0.86	1	
TW16-20-10H	16	200	100	22 x 8.5	1.01	1	
TW28-30-12-2K	28	300	120	28 x 11	1.68	1	
TW28-30-14-2K	28	300	140	28 x 11	1.70	1	
TW28-30-12K	28	300	120	28 x 11	1.62	1	
TW28-30-14K	28	300	140	28 x 11	1.65	1	
TW28-30-12H	28	300	120	28 x 11	2.07	1	
TW28-30-14H	28	300	140	28 x 11	2.08	1	

3D CAD data in the download area of the BESSEY website

Clamping element with gripping arm TW28GRS



Order number	Hole Ø	Opening	Throat depth	Rail	Weight	PU	
		mm	mm	mm	kg	qty.	V3
TW28GRS30-12	28	300	120	28 x 11	2.26	1	

3D CAD data in the download area of the BESSEY website

- Clamping force up to 5,000 N
- The spindle is located on the outside for free access to the work area and to protect against welding spatter
- Special, sturdy V-grooved pressure plate, ideal even for clamping round or square workpieces
- Pivotal and infinitely adjustable in terms of height
- Particularly suited to clamping with the tightest of space constraints, in narrow openings as well as for short projections

You will find accessories on page 3

Clamp on welding tables

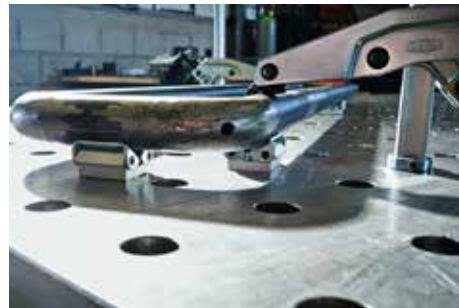

Clamping element with special pressure plate TWM28



Order number	Hole \varnothing	Opening	Throat depth	Rail	Weight	PU	
		mm	mm	mm	kg	qty.	V3
TWM28-30-12	28	300	120	28 x 11	1.78	1	

3D CAD data in the download area of the BESSEY website

- Clamping force up to 6,500 N
- Precise, individual clamping
- Tempered profile and sliding arm for sprung and elastic clamping
- Tempered spindle – particularly sturdy and wear-resistant – for noticeably improved service life
- Long life due to heat-resistant pressure plate with sintered steel insert, which can be tilted up to 35°

Special pressure plate



Order number	Description	Suitable for	Weight	PU	
	mm	mm	kg	qty.	V3
3100736	Standard	SLM, SGM, SGTm, STBM, STBVC, SGU, SLV, GSV, SPZ80K, TWM	0.23	1	
3100737	Standard	STBS, STBU	0.26	1	
3101192	Serrated	SLM, SGM, SGTm, STBM, STBVC, SGU, SLV, GSV, SPZ80K, TWM	0.18	1	
3101193	V-grooved	SLM, SGM, SGTm, STBM, STBVC, SGU, SLV, GSV, SPZ80K, TWM	0.27	1	

- Long life due to heat-resistant pressure plate with sintered steel insert, which can be tilted up to 35°

Three design versions:

- Smooth faced (standard version)
- Rough faced for secure clamping on dirty surfaces
- V-groove face for round, oval and edged workpieces

Vario table clamping attachment TWVAD (2 pcs./bag)



Order number	Hole \varnothing	Angle	Jaw face width	Weight	PU	
	mm		mm	kg	qty.	V3
TW16VAD	16	from 60° inner to 60° outer	45	0.38	1	
TW28VAD	28		45	0.57	1	
TWVAD	–		45	0.28	1	

3D CAD data in the download area of the BESSEY website

- Specifically adapted to round, oval and square workpieces
- Angle infinitely adjustable from 60° internal to 60° external

Various design versions:

- TW16VAD/TW28VAD – version with bolt – for rapidly aligning and fixing the workpiece to the welding table
- TWVAD – version without bolt – for variable movement on the welding table



Toggle clamp adapter TWA-STC



TW16A-STC



TW28A-STC



Order number	Hole Ø	Suitable for	Thread	Weight	PU	
	mm	mm		kg	qty.	V3
TW16A-STC	16	STC-HH STC-IHH	M5	0.19	1	
TW28A-STC	28	STC-VH	M6	0.28	1	

- Accessory for BESSEY STC toggle clamp with horizontal base plate
- With bolt – for use directly on the welding table
- Without bolt – for screwing to the extension TWX

3D CAD data in the download area of the BESSEY website

Extension TWX



Order number	Hole Ø	Suitable for	Adjusting range	Weight	PU	
	mm	mm		kg	qty.	V3
TW16X	16	TW16A-STC TW16VAD TWWAD	15-200	0.41	1	
TW28X	28	TW28A-STC TW28VAD TWWAD TW28AV	15-300	1.76	1	

- Accessory for BESSEY toggle clamp adapter TWA-STC, TWVAD and TW28AV
- Lowering of round workpieces is infinitely adjustable using the adjusting ring in the table

3D CAD data in the download area of the BESSEY website

Tilting adapter TW28AV



Order number	Hole Ø	Opening	Suitable for	Weight	PU	
	mm	mm	mm	kg	qty.	V3
TW28AV	28	160	TW28X	0,90	1	

- Clamping force up to 3,000 N
- Accessory for BESSEY extension TW28X
- Pivoting spindles with stepless adjustment from -52° to +52°
- Lockable trapezoidal nut for secure fastening of the workpiece
- High quality, 2-component plastic grip with long spindle

3D CAD data in the download area of the BESSEY website

With self-adjusting opening fix quickly



**Even more flexible clamping
up to 5-times faster**

Uncompromisingly versatile
One size of the BESSEY toggle clamp replaces multiple competitor sizes simultaneously:

- due to an extremely large clamping range, thanks to the patented mechanism



**Ready to go – the first time and for quick set-up
during workpiece changes**
BESSEY STC toggle clamps adapt to workpieces of varying thickness – without manual setting of the spindle and, with practically the same clamping force:

- due to an automatic clamping width range

Powerful and gentle
Even sensitive workpieces, e. g. with veneered or varnished surfaces, can be gently clamped:

- due to moving pressure plate with removable protective cap
- due to clamping force regulation via adjustment screw in the joint





Horizontal toggle clamp with open arm and horizontal base plate STC-HH



Order number	Opening	Automatic adjustment	Clamping force	Weight	PU	
	mm	mm	appr. N	kg	qty.	V3
STC-HH20	35	20	1,100	0.20	6	
STC-HH20SB	35	20	1,100	0.20	3	
STC-HH50	40	35	2,500	0.38	6	
STC-HH50SB	40	35	2,500	0.38	3	
STC-HH70	60	35	2,500	0.42	6	
STC-HH70SB	60	35	2,500	0.42	3	

Push/pull clamp with horizontal base plate STC-IHH



Order number	Opening	Automatic adjustment	Clamping force	Weight	PU	
	mm	mm	appr. N	kg	qty.	V3
STC-IHH15	25	8	1,100	0.19	6	
STC-IHH25	35	13	2,500	0.45	6	
STC-IHH25SB	35	13	2,500	0.46	3	

- Automatic and infinitely variable adjustment of the clamping height while clamping force remains unchanged – without having to make manual changes to the position of the pressure screws
- Adjustable clamping force based on the adjusting screw in the joint
- Sturdy, tempered metal sheets for a long service life
- Base plate hole pattern suitable for millimetres and inches
- High-quality oil-resistant two-component plastic handle

Vertical toggle clamp with open arm and horizontal base plate STC-VH



Order number	Opening	Automatic adjustment	Clamping force	Weight	PU	
	mm	mm	appr. N	kg	qty.	V3
STC-VH20	35	20	1,100	0.22	6	
STC-VH50	40	35	2,500	0.43	6	

3D CAD data at "<http://bessey.partcommunity.com>", "<https://www.traceparts.com>" and in the download area of the BESSEY website

You will find accessories on page 19

Instant and easy to apply clamping force



Your benefits at a glance:

1 Flexible in application

The work table clamps BS, BSG and the claw machine clamp GRS can be tilted and are infinitely adjustable.

2 Rapid in application

The BS identifies a lever mechanism that facilitates quick clamping and releasing

3 In the tightest space

When unobstructed access to the work area is a requirement or when clamping has to be done in confined spaces, the claw machine clamp GRS provides the necessary function thanks to an externally-positioned spindle.

4 Special tilting pressure plate

The BSG work table clamp has a heat-resistant pressure plate which is replaceable and can be tilted up to 35° so it can even clamp on angled or sloping surfaces. It has an extremely long service-life due to the oil-soaked sintered steel insert's excellent sliding and emergency running properties.



Hold down table clamp BS



Order number	Opening	Throat depth	Rail	Fixing screw hole Ø	Weight	PU	V3
	mm	mm	mm	mm	kg	qty.	
BS2N	200	100	19.5 x 9.5	10.5	1.35	1	
BS3N	200	120	22 x 10.5	13	1.55	1	
BS4N	200	120	28 x 11	16.5	2.49	1	
BS5N	240	140	30 x 15	16.5	3.30	1	
BS6N	500	140	30 x 15	16.5	4.00	1	

- Clamping force up to 10,000 N
- Tilting and infinitely height-adjustable
- For drilling and light milling work
- Lever mechanism for rapid clamping and release

Claw machine clamp GRS



Order number	Opening	Throat depth	Rail	Fixing screw hole Ø	Weight	PU	V3
	mm	mm	mm	mm	kg	qty.	
GRS20-12	200	123-140	28 x 11	16.5	2.81	1	

- Clamping force up to 7,500 N
- Swivelling, vertically infinitely adjustable clamp
- Externally-positioned spindle to allow unobstructed access to the work area and clamping in confined spaces
- For drilling and light milling work

Hold down table clamps BSG



Order number	Opening	Throat depth	Rail	Fixing screw hole Ø	Weight	PU	V3
	mm	mm	mm	mm	kg	qty.	
BSG21-14	210	140	30 x 15	16.5	3.22	1	

- Clamping force up to 12,000 N
- For fastening to tables and other equipment
- Long life due to heat-resistant pressure plate with sintered steel insert, which can be tilted up to 35°

3D CAD data in the download area of the BESSEY website

You will find accessories on page 19

With extra-high clamping pressure, space saving design



Your benefits at a glance:

1 Housings and clamping arms made from tempered stainless steel
 BAS clamps are approx. 30 % smaller than comparable tools made by competitors and still provide the same high clamping forces. At a perpendicular to the jaw face, the self-locking worm gear unit exerts up to 16,000 N.

2 Clamping arm variants with polyamide seal
 To provide for gentle clamping with optimum weight distribution, the short and long clamping arms of the BAS models are equipped with a swivelling aluminium pressure shoe. And when clamping has to be done in corners, BSP models equipped with a pointed clamping arm are the perfect tools. A special polyamide seal protects the interior against dirt.

3 Open or closed fastening holes
 Models with an open hole can be clamped and unclamped more quickly. In closed versions, the screw, nut and clamp form a unit.

4 Space saving and adjustable
 The compact design, both in height and surface requirements, distinguishes all of the models. Clamping height can be increased progressively in 80 mm steps with the BESSEY BASO base unit. When using more than one base unit, care must be taken to provide precise workpiece contact surfaces.



**BAS-C compact clamp,
fixing hole open**



Order number	Opening	Throat depth	Weight		PU	V3
			kg	qty.		
BAS-C9-4	88	40	1.30	1		
BAS-C10-6	97	60	1.30	1		
BSP-C10-6	97	60	1.30	1		

- Clamping force up to 16,000 N
- Space-saving construction, thus up to 30 % smaller than comparable competitive models
- Housing and pressure arm made from hardened and tempered stainless steel, making it extremely robust and durable
- Available in three pressure arm versions: Short and long pressure arm with swivelable aluminium pressure shoe or pointed pressure arm for clamping on narrow sections or in confined spaces
- BAS-C with open fixing hole and BAS-CB with closed fixing hole for M10/M12

**BAS-CB compact clamp,
fixing hole closed**



Order number	Opening	Throat depth	Weight		PU	V3
			kg	qty.		
BAS-CB9-4	88	40	1.30	1		
BAS-CB10-6	97	60	1.30	1		
BSP-CB10-6	97	60	1.30	1		

Base unit BASO



Order number	Opening	Fastening thread	For socket head screw DIN 912	Weight		PU	V3
				kg	qty.		
BASO	80	M10	M10 / M12	0.45	1		

- 80 mm extension
- Stackable
- Fastening hole open, including cheese head screw
- Suitable for all BESSEY BAS clamps

3D CAD data in the download area of the BESSEY website

You will find accessories on page 19

Cut sheet metal safely and reliably



Shape and straight cutting snips



Order number	Overall length		Blade length		↓ max. ↑	⚙️	Weight		PU	V4	
	mm	"	mm	"			kg	qty.			
D29ASS-2	260	10 ¼	33	1 5/16	1.2	+++	0.51	5			
D29ASSL-2	260	10 ¼	33	1 5/16	1.2	+++	0.51	5			
D29ASS-2-SB	260	10 ¼	33	1 5/16	1.2	+++	0.51	5			
D29ASSL-2-SB	260	10 ¼	33	1 5/16	1.2	+++	0.51	5			
Order number	Layout						Weight		PU		V4
	mm						kg	qty.			
DSET29-15	1 x D29ASS-2, 1 x D29ASSL-2 and 1 x D15A in snips pouch						1.29	1			

- ERGO-handle for increased comfort – reduced hand fatigue!
- For continuous, straight and curved cuts
- Compact cutter head: High manoeuvrability for shape cutting
- Optimised leverage ratio: 25 % less effort
- Optimised edge shape: No slipping even without serrations
- Available in right or left cutting versions

Shape and straight cutting snips, small and manoeuvrable



Order number	Overall length		Blade length		↓ max. ↑	⚙️	Weight		PU	V4	
	mm	"	mm	"			kg	qty.			
D15A	180	7	20	3/8	1.0	+++	0.18	10			
D15AL	180	7	20	3/8	1.0	+++	0.18	10			
D15A-SB	180	7	20	3/8	1.0	+++	0.18	10			
D15AL-SB	180	7	20	3/8	1.0	+++	0.18	10			
Order number	Layout						Weight		PU		V4
	mm						kg	qty.			
DSET15	1 x D15A, 1 x D15S and 1 x D15AL in snips pouch						0.61	20			

- For long continuous, straight and curved cuts
- The extremely small forged heads have optimized blade geometry is very manoeuvrable; perfect for cutting small radii and in confined spaces
- The compact design results in the highest performance with the minimum of effort
- ERGO-handle for increased comfort reduced hand fatigue!
- Available in right or left cutting versions

↓
max.
↑ Sheet thickness (600 N/mm²)

⚙️ Product life expectancy





Aviation snips



D16 D16L D16S



Order number	Overall length		Blade length		↓ max. ↑	⚙️	Weight		PU	V4
	mm	"	mm	"			kg	qty.		
D16	240	9 ½	40	1 ⅞	1.2	++	0.38	10		
D16L	240	9 ½	40	1 ⅞	1.2	++	0.38	10		
D16S	240	9 ½	40	1 ⅞	1.2	++	0.38	10		
Order number	Layout					Weight		PU		V4
	mm					kg	qty.			
DSET16	1 x D16, 1 x D16L and 1 x D16S in snips pouch					1.23	1			

D16/D16L

- For short, straight and curved cuts
- Edges with micro-serrations for slip-proof working

D16S

- No offset to blades, for short, straight and curved cuts with a large radius in both left and right directions
- Edges with micro-serrations for slip-proof working
- Available only in left cutting version

Shape and straight cutting snips



Order number	Overall length		Blade length		↓ max. ↑	⚙️	Weight		PU	V5
	mm	"	mm	"			kg	qty.		
D216-260	260	10 ¼	30	1 ⅜	1.0	++	0.49	5		
D216-260L	260	10 ¼	30	1 ⅜	1.0	++	0.49	5		
D216-280	280	11	34	1 ⅜	1.0	++	0.58	5		
D216-280L	280	11	34	1 ⅜	1.0	++	0.58	5		
D116-260	260	10 ¼	30	1 ⅜	1.0	+	0.49	5		
D116-260L	260	10 ¼	30	1 ⅜	1.0	+	0.49	5		
D116-280	280	11	34	1 ⅜	1.0	+	0.56	5		
D116-280L	280	11	34	1 ⅜	1.0	+	0.56	5		

↓
max.
↑ Sheet thickness (600 N/mm²)
⚙️ Product life expectancy

- For continuous, straight and curved cuts
- D216 – Painted handles
- D116 – PVC dipped handles
- Available in right or left cutting versions

Quality of steel	min. hardness Rockwell C	Durability
Special high quality	61	+++
High quality steel	59	++
Standard quality steel	56	+

Clamping tools and Cutting tools by professionals for professionals



When it comes to innovative solutions for clamping and fixing workpieces and cutting sheet metal, this is the right place. No matter if classic clamps, traditional sheet metal snips or special solutions are required for special work requirements, BESSEY offers the right clamping and cutting tool for every craftsman in wood and metalworking in order to optimally support it in its work.

www.bessey.de

Detailed information
about all products at
www.bessey.de/en-gb

Clamping tools

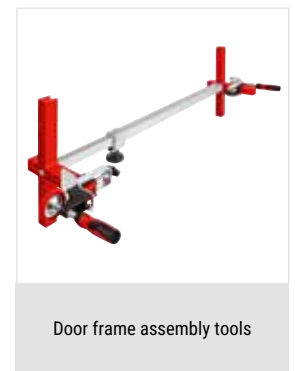
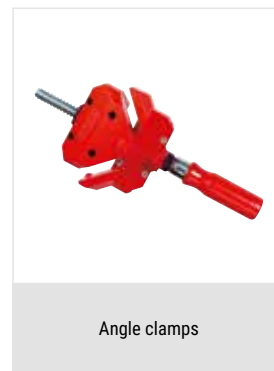
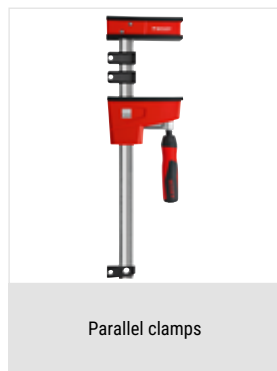
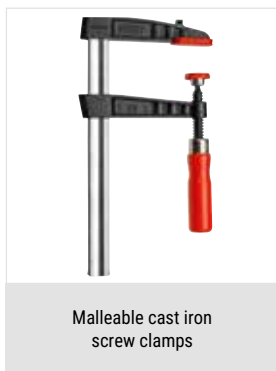

Cutting tools

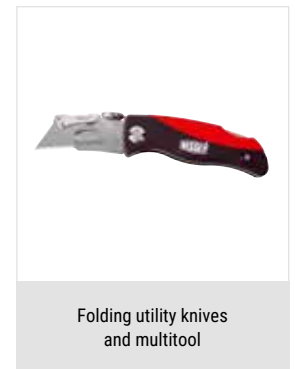
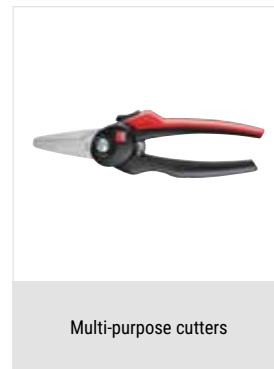
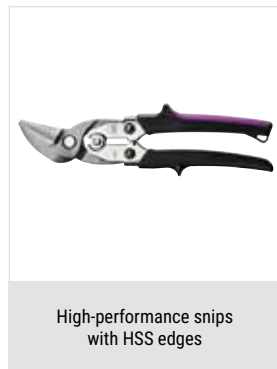
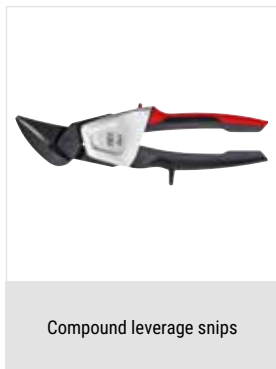

BESSEY Tool GmbH & Co. KG ■ Mühlwiesenstraße 40
74321 Bietigheim-Bissingen, Germany
Fon +49 7142 401-0 ■ Fax +49 7142 401-452
E-Mail: tool-info@bessey.de

Your dealer:

More information
www.bessey.de

