















BESSEY Lista per accessori e pezzi di ricambio 2025/2026

<p>4-7 Strettoi a vite con ganasce in ghisa malleabile</p>	<p>17 Strettoi a braccio serrante</p>	<p>23 Strettoio manuale</p>
 <p>TG / TPN TGK / TKPN TGNT</p>	 <p>GRA...12</p>	 <p>KS</p>
<p>8-11 Strettoi a vite in acciaio</p>	<p>17 Strettoi rapidi variabili</p>	<p>23 Strettoi con canasce piane</p>
 <p>GZ / GS G...Z GU25-12-6ZK GMZ</p>	 <p>STC-VH / STC-HH STC-HV / STC-HA STC-IHH / STC-IHA TW..A-STC TW..VAD / TWVAD</p>	 <p>FK</p>
<p>12-13 Strettoi a leva</p>	<p>18-20 Elementi di serraggio</p>	<p>23 Strettoio ad ingranaggio GearKlump</p>
 <p>GH / GSH GHS / G...H</p>	 <p>TWV / TW TWM28 TW28GRS WNS-SET-MFT</p>	 <p>GK</p>
<p>14-15 Strettoi ad elevate prestazioni</p>	<p>21 Staffaggi rapidi per macchine utensili</p>	<p>24 Strettoi utilizzabili con una sola mano</p>
 <p>SLM / SGM / SGL SG...M / STBM STBS / STBVC SGU / STBU GSL / GSM</p>	 <p>BAS BSN SGHS</p>	 <p>EHZ / EZS / EZ</p>
<p>16 Strettoi a vite variabili</p>	<p>22 Strettoi manuali</p>	<p>25 Strettoio per tetti</p>
 <p>SLV / GSV</p>	 <p>KRE / KREV KR / KRV / K</p>	 <p>SPZ</p>

26 **Pinze grip**



26 **KliKlamp**



27 **Strettoio a vite e morsa per serraggio**



27 **Morsetti da banco**



28 **Strettoii a nastro**



29 **Strettoio per bordi e portapiastre**



29 **Aggraffatore**



30-31 **Utensili per montaggio dei telai porte e finestre telai porte**

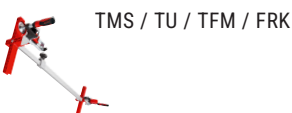

32-33 **Telescopica di supporto**



34 **Cesoie per lamiere a leva**



35 **Cesoie per lamiere normali**



36 **Coltello con lama ripieghevole nel manico**



La progettazione di prodotto BESSEY si riserva di apportare modifiche tecniche.
Per errori di stampa non assumiamo nessuna responsabilità.

BESSEY Lista per accessori e pezzi di ricambio 2025/2026



Strettoi a vite con ganasce in ghisa malleabile

adatti per la serie TG e TPN

	Parte inferiore cpl. con impugnatura in plastica 2 componenti		Impugnatura in plastica 2 componenti con piastra di pressione con cappuccio protettivo			Asta di scorrimento con impugnatura in legno		Impugnatura in legno con piastra di pressione in acciaio di alta qualità con cappuccio protettivo		
	Scartamento mm	Per guida mm	Lunghezza x Ø mm	Testa Ø mm	Filettatura trapezoidale mm	Scartamento mm	Per guida mm	Lunghezza x Ø mm	Testa Ø mm	Filettatura trapezoidale mm
TG10 / TG...B5										
No. d'ordine	-			-		-			-	
TG12 / TG...B6										
No. d'ordine	-			-		-			-	
TG16 TG...B8 TPN16 TPN...B8			110 x 30	10	14 x 4					
No. d'ordine	-		3101179			-			-	
TG20 TG...S10 TPN20 TPN...S10			110 x 30	12	16 x 4	100	27 x 7	112 x 30	12	16 x 4
No. d'ordine	-		3101182			3101413		3101386		
TG25 TG...S12 TPN25 TPN...S12	120	29 x 9	130 x 34	12	16 x 4	120	29 x 9	125 x 32	12	16 x 4
No. d'ordine	3101832		3101186			3101414		3101389		
TG30 TG...S14 TPN30 TPN...S14	140	32 x 10	130 x 34	13	18 x 5	140	32 x 10	140 x 35	13	18 x 5
No. d'ordine	3101833		3101187			3101415		3101390		
TG40 TG...S17	175	32 x 10	130 x 34	13	18 x 5	175	32 x 10	140 x 35	13	18 x 5
No. d'ordine	3101834		3101187			3101416		3101390		
TPN40 TPN...S17	175	32 x 10	130 x 34	13	18 x 5	175	32 x 10	140 x 35	13	18 x 5
No. d'ordine	3101834		3101187			3101416		3101390		

Strettoi a vite con ganasce in ghisa malleabile

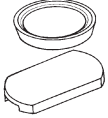
adatti per la serie TG e TPN

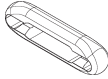
	Piastra di pressione sostituibile dalla taglia 16	Guaina per ganasca fissa e mobile		Protezioni SKS	Rialzo per traversino KA
					
	4 Paia	10 Paia		2 Pz.	2 Pz.
	Ø mm	per Ø mm	per larghezza mm		adatto solo per varianti con traversino
TG10 / TG...B5	22	22	17		
No. d'ordine	3101339	3101391		-	-
TG12 / TG...B6	22	22	19		
No. d'ordine	3101339	3101392		-	-
TG16 TG...B8 TPN16 TPN...B8	25,5	25,5	23		
No. d'ordine	3101180	3101393		-	-
TG20 TG...S10 TPN20 TPN...S10	32	32	28		
No. d'ordine	3101183	3101394		-	3101194*
TG25 TG...S12 TPN25 TPN...S12	32	32	30		
No. d'ordine	3101183	3101395		-	3101194*
TG30 TG...S14 TPN30 TPN...S14	38,5	38,5	32		
No. d'ordine	3101188	3101396		-	3101194*
TG40 TG...S17	38,5	38,5	32		
No. d'ordine	3101188	3101396		-	3101194*
TPN40 TPN...S17	38,5				
No. d'ordine	3101188	-		SKS20/40	3101194*

*Nei limiti dello stock disponibile

BESSEY Lista per accessori e pezzi di ricambio 2025/2026

Strettoi a vite con ganasce in ghisa malleabile

adatti per la serie TGK e TKPN

	Parte inferiore cpl. con impugnatura in plastica 2 componenti		Impugnatura in plastica 2 componenti con piastra di pressione cappuccio protettivo			Parte inferiore cpl. con impugnatura in legno		Impugnatura in legno con piastra di pressione in acciaio di alta qualità con cappuccio protettivo		
	Scartamento mm	Per guida mm	Lunghezza x Ø mm	Testa Ø mm	Filettatura trapezoidale mm	Scartamento mm	Per guida mm	Lunghezza x Ø mm	Testa Ø mm	Filettatura trapezoidale mm
TGK TKPN	120	35 x 11	130 x 34	13	18 x 5	120	35 x 11	140 x 35	13	18 x 5
No. d'ordine	3101838		3101187			3101417		3101390		



Strettoi a vite con ganasce in ghisa malleabile

adatti per la serie TGK e TKPN

	Traversino		Piastra di pressione sostituibile	Guaina per ganasca fissa e mobile SKS		Rialzo per traversino KA
	Scartamento	Per guida mm	Ø mm	per Ø mm	per larghezza mm	adatto solo per varianti con traversino
TGK TKPN			38,5	25,5	23	
No. d'ordine	-		3101188	SKS20/40		3101194*
TGK-K	120	35 x 11	38,5	25,5	23	
No. d'ordine	3101418		3101188	SKS20/40		3101194*

Strettoi a vite per grande profondità

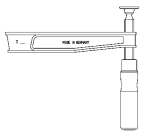
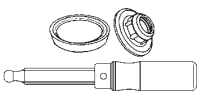
adatti per la serie TGNT

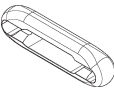
	Parte inferiore cpl. con impugnatura in legno		Impugnatura in plastica 2 componenti con piastra di pressione con cappuccio protettivo			Piastra di pressione sostituibile	Rialzo per traversino KA
							
	Scartamento mm	Per guida mm	Lunghezza x Ø mm	Testa Ø mm	Filettatura trapezoidale mm	Ø mm	adatto solo per varianti con traversino
TGN...T20	200	35 x 11	140 x 35	13	18 x 5	38,5	
No. d'ordine	3101419		3101390			3101188	3101194*
TGN...T25	250	40 x 11	140 x 35	13	18 x 5	38,5	
No. d'ordine	3101420		3101390			3101188	3101194*
TGN...T30	300	45 x 12	140 x 35	13	18 x 5	38,5	
No. d'ordine	3101421		3101390			3101188	3101194*
TGN...T40			140 x 35	13	18 x 5	38,5	
No. d'ordine	-		3101390			3101188	3101194*
TGN...T50			140 x 35	13	18 x 5	38,5	
No. d'ordine	-		3101390			3101188	3101194*



BESSEY Lista per accessori e pezzi di ricambio 2025/2026**Stretti a vite in acciaio – nuovo a partire dal 01.07.09**

adatti per la serie GZ

	Asta di scorrimento completo con impugnatura in plastica 2 componenti		Impugnatura in plastica 2 componenti con piastra di pressione con cappuccio protettivo			Asta di scorrimento completo con impugnatura in legno		Impugnatura in legno con piastra di pressione in acciaio di alta qualità con cappuccio protettivo		
	Apertura mm	Per guida mm	Lunghezza x Ø mm	Testa Ø mm	Filettatura trapezoidale mm	Apertura mm	Per guida mm	Lunghezza x Ø mm	Testa Ø mm	Filettatura trapezoidale mm
GZ10 / GZ12										
No. d'ordine	-		-			-		-		
GZ16			110 x 30	10	14 x 4					
No. d'ordine	-		3101179			-		-		
GZ20 GZ...-10	100	22 x 8,5	110 x 30	12	16 x 4	100	22 x 8,5	112 x 30	12	16 x 4
No. d'ordine	3101955		3101182			3101516		3101386		
GZ25 GZ...-12	120	24 x 9,5	130 x 34	12	16 x 4	120	24 x 9,5	125 x 32	12	16 x 4
No. d'ordine	3101835		3101186			3101517		3101389		
GZ30	140	28 x 11	130 x 34	13	18 x 5	140	28 x 11	140 x 35	13	18 x 5
No. d'ordine	3101836		3101187			3101518		3101390		
GZ40 – GZ125	120	28 x 11	130 x 34	13	18 x 5	120	28 x 11	140 x 35	13	18 x 5
No. d'ordine	3101837		3101187			3101519		3101390		

Strettoi a vite in acciaio – nuovo a partire dal 01.07.09

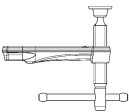
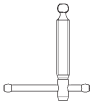
adatti per la serie GZ

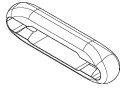
Asta di scorrimento completo con traversino		Traversino	Impugnatura ribaltabile in plastica 2 componenti con piastra di pressione con cappuccio protettivo			Piastra di pressione sostituibile dalla taglia 16	Rialzo per traversino KA
							
Apertura mm	Per guida mm	Filettatura trapezoidale mm	Lunghezza x Ø mm	Testa Ø mm	Filettatura trapezoidale mm	Ø mm	adatto solo per varianti con traversino
GZ10 / GZ12						22	
No. d'ordine	-	-		-		3101339	-
GZ16		14 x 4				25,5	
No. d'ordine	-	3101795		-		3101180	-
GZ20 GZ...-10	100 22 x 8,5	16 x 4				32	
No. d'ordine	3101441	3101796		-		3101183	3101194*
GZ25 GZ...-12	120 24 x 9,5	16 x 4	125 x 35	12	16 x 4	32	
No. d'ordine	3101444	3101796	3101958			3101183	3101194*
GZ30	140 28 x 11	18 x 5				38,5	
No. d'ordine	3101447	3101797		-		3101188	3101194*
GZ40 – GZ125	120 28 x 11	18 x 5				38,5	
No. d'ordine	3101450	3101797		-		3101188	3101194*

*Nei limiti dello stock disponibile

BESSEY Lista per accessori e pezzi di ricambio 2025/2026

Stretti a vite OMEGA, stretti a vite in acciaio classiX

Stretti a vite in acciaio – vecchia versione a partire dal 30.06.09



adatti per la serie GMZ, G...Z, GS

	Asta di scorrimento completo con impugnatura in legno		Asta di scorrimento completo con traversino		Impugnatura in legno con piastra di pressione in acciaio di alta qualità con cappuccio protettivo			Impugnatura in plastica 2 componenti con piastra di pressione con cappuccio protettivo		
	Apertura mm	Per guida mm	Apertura mm	Per guida mm	Lunghezza x Ø mm	Testa Ø mm	Filettatura trapezoidale mm	Lunghezza x Ø mm	Testa Ø mm	Filettatura trapezoidale mm
G10Z / G12Z GS10 / GS12										
No. d'ordine	-		-		-			-		
G16Z / GS16								110 x 30	10	14 x 4
No. d'ordine	-		-		-			3101179		
G20Z/G...-S10Z GS20 GM20Z GM...S10Z	100	19,5 x 9,5	100	19,5 x 9,5	112 x 30	12	16 x 4	110 x 30	12	16 x 4
No. d'ordine	3101422		3101800		3101386			3101182		
G25Z/G...-S12Z GS25 GM25Z GM...-S12Z GU25-12-6ZK	120	22 x 10,5	120	22 x 10,5	125 x 32	12	16 x 4	130 x 34	12	16 x 4
No. d'ordine	3101423		3101801		3101389			3101186		
G30Z / GS30 GM30Z	140	25 x 12	140	25 x 12	140 x 35	13	18 x 5	130 x 34	13	18 x 5
No. d'ordine	3101424		3101802		3101390			3101187		
G40Z – G60Z GS40 – GS60 GM40Z – GM60Z	120	25 x 12	120	25 x 12	140 x 35	13	18 x 5	130 x 34	13	18 x 5
No. d'ordine	3101425		3101803		3101390			3101187		
G80Z – G125Z GS80 – GS100 GM80Z – GM125Z	120	27 x 13	120	27 x 13	140 x 35	13	18 x 5	130 x 34	13	18 x 5
No. d'ordine	3101426		3101804		3101390			3101187		

Strettoi a vite OMEGA, Strettoi a vite in acciaio classiX

Strettoi a vite in acciaio – vecchia versione a partire dal 30.06.09

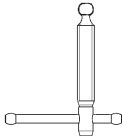
adatti per la serie GMZ, G...Z, GS

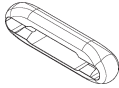
	Traversino	Piastra di pressione sostituibile dalla taglia 16	Rialzo per traversino KA
			
		4 Paia	2 Pz.
	Filettatura trapezoidale mm	Ø mm	adatto solo per varianti con traversino
G10Z / G12Z GS10 / GS12		22	
No. d'ordine	-	3101339	-
G16Z / GS16	14 x 4	25,5	
No. d'ordine	3101795	3101180	-
G20Z/G...-S10Z GS20 GM20Z GM...S10Z	16 x 4	32	
No. d'ordine	3101796	3101183	3101194*
G25Z/G...-S12Z GS25 GM25Z GM...-S12Z GU25-12-6ZK	16 x 4	32	
No. d'ordine	3101796	3101183	3101194*
G30Z / GS30 GM30Z	18 x 5	38,5	
No. d'ordine	3101797	3101188	3101194*
G40Z - G60Z GS40 - GS60 GM40Z - GM60Z	18 x 5	38,5	
No. d'ordine	3101797	3101188	3101194*
G80Z - G125Z GS80 - GS100 GM80Z - GM125Z	18 x 5	38,5	
No. d'ordine	3101797	3101188	3101194*

*Nei limiti dello stock disponibile

BESSEY Lista per accessori e pezzi di ricambio 2025/2026

Strettoi a leva – GH – nuovo a partire dal 01.03.10

adatti per la serie GH

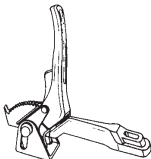
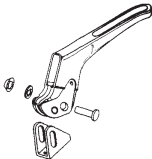
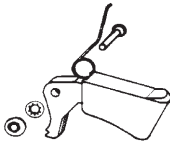
	Asta di scorrimento completa		Leva con cappuccio di pressione completa	Leva di sbloccaggio completa
	Scartamento mm	Per guida mm	Perno-Ø x l mm	Perno-Ø x l mm
				 2 Pz.
GH12 GH16				5h11 x 21
No. d'ordine	-		-	3101399
GH20 GH...-10	100	22 x 8,5	10 x 33,5	5h11 x 23
No. d'ordine	3101522		3101397	3101400
GH25 GH...-12	120	24,5 x 9,5	10 x 33,5	5h11 x 23
No. d'ordine	3101523		3101397	3101400
GH30	140	28 x 11	12 x 38	5h11 x 26
No. d'ordine	3101524		3101398	3101401
GH40 – GH100	120	28 x 11	12 x 38	5h11 x 26
No. d'ordine	3101525		3101398	3101401



Strettoi a leva classiX – GSH

Strettoi a leva – GH – **vecchia versione a partire dal 28.02.10**

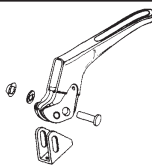
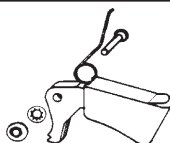

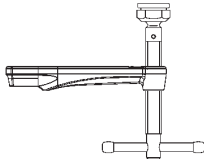
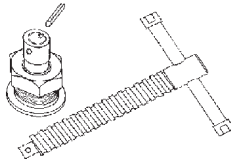

adatti per la serie G...H, GSH

	Asta di scorrimento completa		Leva con cappuccio di pressione completa	Leva di sbloccaggio completa
	Scartamento mm	Per guida mm	Perno-Ø x l mm	Perno-Ø x l mm
G12H / G...S6H G16H / G...S8H GSH12 – GSH16				 2 Pz.
No. d'ordine	-		-	3101399
G20H / G...S10H GSH20	100	19,5 x 9,5	10 x 33,5	5h11 x 23
No. d'ordine	3101333		3101397	3101400
G25H / G...S12H GSH25 GU-H	120	22 x 10,5	10 x 33,5	5h11 x 23
No. d'ordine	3101334		3101397	3101400
G30H GSH30	140	25 x 12	12 x 38	5h11 x 26
No. d'ordine	3101335		3101398	3101401
G40H – G60H GSH40 – GSH60	120	25 x 12	12 x 38	5h11 x 26
No. d'ordine	3101336		3101398	3101401
G80H – G100H	120	27 x 13	12 x 38	5h11 x 26
No. d'ordine	3101337		3101398	3101401

BESSEY Lista per accessori e pezzi di ricambio 2025/2026**Strettoi ad elevate prestazioni – SLM e SGM – nuovo a partire dal 01.07.08**

	Asta di scorrimento completa		Kombi-Set (Fuso, piastra di pressione, perno di pressione)		Rialzo per traversino KA
					
	Scartamento mm	Per guida mm	Filettatura trapezoidale mm	Traversino mm	2 Pz.
SL...M	120	28 x 11	18 x 5	10 x 120	
No. d'ordine	3101521		3100398		3101194*
SG...M	140	34 x 13	20 x 5	11 x 120	
No. d'ordine	3101407		3100399		-

Strettoi ad elevate prestazioni – SLM/SGM/STBM/STBVC/SGU/STBU/STBS

	Piastra di pressione standard ad alta prestazione		Piastra di pressione ad alta prestazione con superficie ruvida		Piastra di pressione ad alta prestazione con scanalatura a V		Bussola filettata con anello di sicurezza	Bietta STBS
								
	Foro per fuso mm	Perno di pressione mm	Foro per fuso mm	Perno di pressione mm	Foro per fuso mm	Perno di pressione mm	Filettatura	2 Pz.
SLM / SGM STBM / STBVC SGU	12	5 x 20	12	5 x 20	12	5 x 20		
No. d'ordine	3100736		3101192		3101193		-	-
STBU	12	5 x 20	12	5 x 20	12	5 x 20		
No. d'ordine	3100737		3101192		3101193		-	-
STBS	12	5 x 20					M 24	
No. d'ordine	3100737		-		-		3100579	3101788

Strettoi ad elevate prestazioni – STBVC/STB/STBS

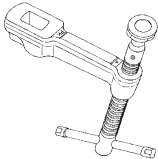
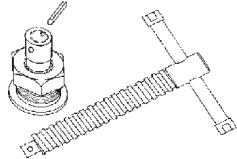
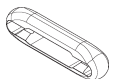

Strettoi ad elevate prestazioni classiX – GSL e GSM

Strettoi ad elevate prestazioni – SGL e SGM – **vecchia versione a partire dal 30.06.08**

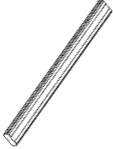
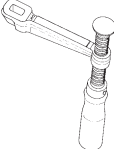
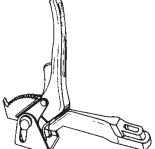
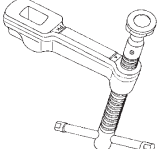

	Asta di scorrimento completa		Kombi-Set (Fuso, piastra di pressione, perno di pressione)		Rialzo per traversino KA
					
	Scartamento mm	Per guida mm	Filettatura trapezoidale mm	Traversino mm	2 Pz.
SGL...M / GSL	120	27 x 13	18 x 5	10 x 120	
No. d'ordine	3101338		3100398		3101194*
SG...M	120	30 x 15	20 x 5	11 x 120	
No. d'ordine	3101329		3100399		-
SG30M / GSM / SGU	140	30 x 15	20 x 5	11 x 120	
No. d'ordine	3101330		3100399		-
SG...T20M	200	30 x 15	20 x 5	11 x 120	
No. d'ordine	3101331		3100399		-
STB...M / STBU	175	40 x 20	22 x 5	11 x 180	
No. d'ordine	3101332		3100400		-
STBS	200	50 x 25	M24	18 x 345	
No. d'ordine	3101798		3100401		-
STBVC	100	40 x 20	22 x 5	11 x 180	
No. d'ordine	3101882		3100400		-

BESSEY Lista per accessori e pezzi di ricambio 2025/2026

Strettoi a vite variabili SLV, GSV

	Guida		Asta di scorrimento con impugnatura in legno completa		Asta di scorrimento con impugnatura a leva completa		Asta di scorrimento con impugnatura a traversino completa		Rialzo per traversino KA
	Apertura mm	Guida mm	Scartamento mm	Per guida mm	Scartamento mm	Per guida mm	Scartamento mm	Per guida mm	
									2 Pz.
SLV	1000	27 x 13	120	27 x 13	120	27 x 13	120	27 x 13	
No. d'ordine	3101731		3101426		3101337		3101338		3101194*
SLV	1500	27 x 13	120	27 x 13	120	27 x 13	120	27 x 13	
No. d'ordine	3101732		3101426		3101337		3101338		3101194*
SLV	2000	27 x 13	120	27 x 13	120	27 x 13	120	27 x 13	
No. d'ordine	3101733		3101426		3101337		3101338		3101194*

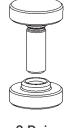

GSV	3000	30 x 15					120	30 x 15	
No. d'ordine	3101612		-		-		3101329		-
GSV	3000	30 x 15					140	30 x 15	
No. d'ordine	3101612		-		-		3101330		-
GSV	3000	30 x 15					200	30 x 15	
No. d'ordine	3101612		-		-		3101331		

	Piastra di pressione standard ad alta prestazione		Piastra di pressione ad alta prestazione con superficie ruvida		Piastra di pressione ad alta prestazione con scanalatura		Blocco di fincorsa
	Foro per fuso mm	Perno di pressione mm	Foro per fuso mm	Perno di pressione mm	Foro per fuso mm	Perno di pressione mm	
							
							2 Paia
SLV / GSV	12	5 x 20	12	5 x 20	12	5 x 20	
No. d'ordine	3100736		3101192		3101193		3101782

Strettoi a braccio serrante- nuovo a partire dal 01.04.12

	Asta di scorrimento completa		Fuso completo	
	Scartamento mm	Per guida mm	Filettatura trapezoidale mm	Traversino mm
GRA...12	120	28 x 11	18 x 5	8 x 110
No. d'ordine	3101590		3100562	

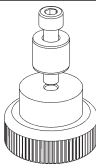
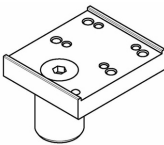
Strettoi rapidi variabili STC

	Set completo aste filettate	Per banchi multifunzione Adattatore	Per banchi di saldatura			
			Adattatore		Prolunga	
			Ø viti mm	Ø viti mm	Ø viti	Modo di regolazione
STC-VH20 / STC-HH20 STC-IHH15		 1 vite cilindrica DIN 912 M 8 x 35 1 perno di innesto D20 x 17 1 dado zigrinato M8				
No. d'ordine	3101627	-	16	28	-	-
STC-HV20 / STC-HA20 STC-IHA15						
No. d'ordine	3101627	-	-	-	-	-
STC-VH50 / STC-HH50 STC-IHH25						
No. d'ordine	3101589	STC-SET-T20	16	28	-	-
STC-HH70						
No. d'ordine	3101588	STC-SET-T20	16	28	-	-
TW16A-STC TW16VAD / TWVAD					16	15-200
No. d'ordine	-	-	-	-	TW16X	
TW28A-STC TW28VAD / TWVAD					28	15-300
No. d'ordine	-	-	-	-	TW28X	

BESSEY Lista per accessori e pezzi di ricambio 2025/2026

Elementi di serraggio con scartamento variabile TWV

	Guida		Titolare croce completa	Impugnatura a 2 componenti completa		Impugnatura a traversino completa		Impugnatura a leva completa		Adattatore per banchi da lavoro
	Altezza serrag- gio	Guida mm	Per guida mm	Scarta- mento mm	Per guida mm	Scarta- mento mm	Per guida mm	Scarta- mento mm	Per guida mm	Adatto per
TWV16	200	22 x 8,5	22 x 8,5	30-150	22 x 8,5	30-150	22 x 8,5	60-150	22 x 8,5	19 mm/3/4"
No. d'ordine	3101740		3101744	3101741		3101742		3101743		TW16AW19
TWV16	200	22 x 8,5	22 x 8,5	30-150	22 x 8,5	30-150	22 x 8,5	60-150	22 x 8,5	20 mm/13/16"
No. d'ordine	3101740		3101744	3101741		3101742		3101743		TW16AW20
TWV16	200	22 x 8,5	22 x 8,5	30-150	22 x 8,5	30-150	22 x 8,5	60-150	22 x 8,5	-
No. d'ordine	3101740		3101744	3101741		3101742		3101743		-
TWV16	200	22 x 8,5	22 x 8,5	30-150	22 x 8,5	30-150	22 x 8,5	60-150	22 x 8,5	30 mm/1 3/16"
No. d'ordine	3101740		3101744	3101741		3101742		3101743		TW16AW30
TWV28	300	28 x 11	28 x 11	40-175	28 x 11	40-175	28 x 11	110-175	28 x 11	-
No. d'ordine	3101706		3101710	3101707		3101708		3101709		-

Tenditore discendente orizzontale per banchi multifunzione WNS-SET-MFT



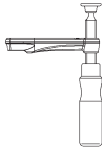
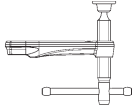
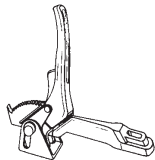
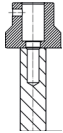

Gancio per banchi multifunzione	
 <p>4 x gancio per banchi 4 x dado zigrinato</p>	
<p>Ø viti mm</p>	
WNS-SET-MFT	20
No. d'ordine	BH-MFT

Elementi di serraggio con scartamento fisso TW

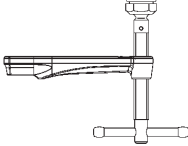

	Guida		Impugnatura a 2 componenti completa		Impugnatura a traversino completa		Impugnatura a leva completa		Adattatore per banchi da lavoro
									
	Altezza serraggio mm	Guida mm	Scartamento mm	Per guida mm	Scartamento mm	Per guida mm	Scartamento mm	Per guida mm	Adatto per
TW16	200	22 x 8,5	100	22 x 8,5	100	22 x 8,5	100	22 x 8,5	19 mm/3/4"
No. d'ordine	3101740		3101516		3101441		3101522		TW16AW19
TW16	200	22 x 8,5	100	22 x 8,5	100	22 x 8,5	100	22 x 8,5	20 mm/13/16"
No. d'ordine	3101740		3101516		3101441		3101522		TW16AW20
TW16	200	22 x 8,5	100	22 x 8,5	100	22 x 8,5	100	22 x 8,5	-
No. d'ordine	3101740		3101516		3101441		3101522		-
TW16	200	22 x 8,5	100	22 x 8,5	100	22 x 8,5	100	22 x 8,5	30 mm/1 3/16"
No. d'ordine	3101740		3101516		3101441		3101522		TW16AW30
TW28	300	28 x 11	120	28 x 11	120	28 x 11	120	28 x 11	-
No. d'ordine	3101706		3101519		3101450		3101525		-
TW28	300	28 x 11	140	28 x 11	140	28 x 11	140	28 x 11	-
No. d'ordine	3101706		3101518		3101447		3101524		-

BESSEY Lista per accessori e pezzi di ricambio 2025/2026



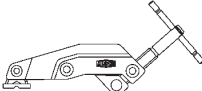

Elementi di serraggio con piastra di pressione speciale TWM28

	Impugnatura a traversino completa e piastra di pressione speciale		Piastra di pressione standard ad alta prestazione		Piastra di pressione ad alta prestazione con superficie ruvida		Piastra di pressione ad alta prestazione con scanalatura V	
								
	Scartamento mm	Per guida mm	Foro per fuso mm	Perno di pressione mm	Foro per fuso mm	Perno di pressione mm	Foro per fuso mm	Perno di pressione mm
TWM28	120	28 x 11	12	5 x 20	12	5 x 20	12	5 x 20
No. d'ordine	3101521		3100736		3101192		3101193	

Elementi di serraggio TW28GRS/TWVAD/TWA-STC/TW28AV

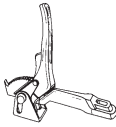

	Guida		Asta di scorrimento completa		Prolunga	
						
	Altezza serraggio mm	Guida mm	Scartamento mm	Per guida mm	Ø viti mm	Modo di regolazione
TW28GRS	300	28 x 11	120	28 x 11		
No. d'ordine	3101706		3101590		-	
TWVAD TW16VAD TW16A-STC					16	15-200
No. d'ordine	-		-		TW16X	
TWVAD TW28VAD TW28A-STC TW28AV					28	15-300
No. d'ordine	-		-		TW28X	

Staffaggi rapidi per macchine utensili BAS, BS, SGHS

	Asta di pressione	Scarpa da pressione	Vite	Asta di scorrimento completa		Dente d'arresto completo
						
		4 Pz.	2 Pz.			2 Pz.
				Apertura mm	Per guida mm	Perno-Ø x l mm
BAS...9-4						
No. d'ordine	3101428	3101431	3101726	-	-	-
BAS...10-6						
No. d'ordine	3101429	3101431	3101726	-	-	-
BSP...10-6						
No. d'ordine	3101430	-	3101726	-	-	-
BS2N / BS3N						5h11 x 26
No. d'ordine	-	-	-	-	-	3100747
BS4N						5h11 x 26
No. d'ordine	-	-	-	-	-	3100748
BS5N / BS6N SG-HS				140	30 x 15	
No. d'ordine	-	-	-	3101432		-

BESSEY Lista per accessori e pezzi di ricambio 2025/2026

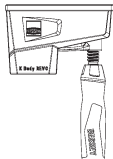
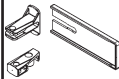
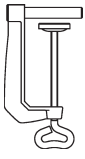
Strettoi manuali KR/KRV/KRE/KREV

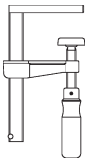
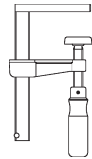
	Parte inferiore cpl. con asta di scorrimento		Set in busta	Morsetto da tavolo		Morsetto da tavolo		Morsetto da tavolo		Morsetto da tavolo	
											
			2 x cappucci protettivi 2 x protezioni 1 x sicura	Ø 8 mm		Ø 8 mm		Ø 8 mm		Ø 8 mm	
	Apertura mm	Per guida mm		Scartamento mm	Apertura mm	Scartamento mm	Apertura mm	Scartamento mm	Apertura mm	Scartamento mm	Apertura mm
KR...-2K KRV...-2K KRE...-2K KREV...-2K	95	29 x 9		60	22	60	28	100	50	150	50
No. d'ordine	3101774		3101775	TK6		RB269		LM10/5R8		LM15/5R8	

Strettoi manuali K/KR/KRV/KRE/KREV

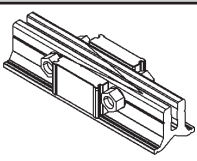
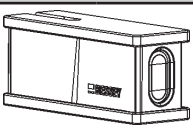
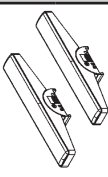
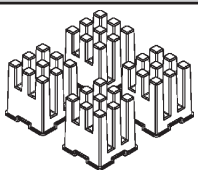
	Prolunga	Parte superiore mobile		Adattatore inclinabile		Set per serraggio telai
						
		Apertura mm	Per guida mm	Larghezza ganasce mm	Altezza ganasce mm	
K...		95	29 x 9			
No. d'ordine	KBX20	KRE-VO		-		KP
KR...-2K KRV...-2K KRE...-2K KREV...-2K		95	29 x 9	170	25	
No. d'ordine	KBX20	KRE-VO		KR-AS		KP

Strettoio manuale KS

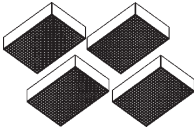
Accessorio die pressione	
 <p>4 Pz./sacchetto</p>	
KS	
No. d'ordine	3101845

Strettoi con ganasce piane FK

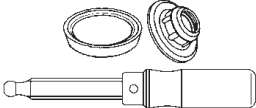
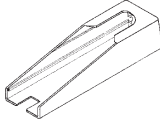
Fuso completo con impugnatura in legno		Cappuccio protettivo
		 <p>2 Pz.</p>
Filettatura trapezoidale mm		Scartamento mm
FK16-8	-	80
No. d'ordine		3101790
FK...-10	16 x 4	100
No. d'ordine	3101386	3101789

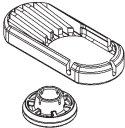

Morsetto a ingranaggio GearKlamp GK

Set di piastra di pressione e cappucci protettivi	
 <p>5 Paia</p>	
Ø mm	
GK	26
No. d'ordine	3101840

BESSEY Lista per accessori e pezzi di ricambio 2025/2026**Strettoi utilizzabili con una sola mano EHZ**

	Set di cappucci protettivi	Set di cappucci protettivi
	 <p>5 Paia Ø mm</p>	 <p>10 Pz. mm</p>
EHZ...-2K		
No. d'ordine	3101402	-
EZS...-8		
No. d'ordine	-	40 x 48 3101841



Strettoi utilizzabili con una sola mano EZ

	Set di cappucci protettivi	Dispositivo di fissaggio
	 <p>10 Pz.</p>	 <p>2 Pz.</p>
EZM		
No. d'ordine	3101959	3101962
EZL		
No. d'ordine	3101960	-
EZXL		
No. d'ordine	3101961	-

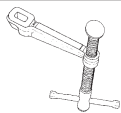
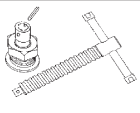
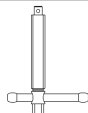
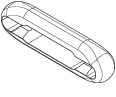

Strettoi utilizzabili con una sola mano EZ360

	Set di cappucci protettivi
	 <p>6 Pz.</p>
EZ360	
No. d'ordine	3102055



Strettoio per tetti SPZ60K e SPZ80K

	Asta di scorrimento completa	Kombi-Set (Fuso, piastra di pressione, perno di pressione)		Fuso		Rialzo per traversino KA	Piastra di pressione sostituibile
		 sin esagono		 con esagono		 2 Pz.	 4 Paia
	Per guida mm	Filettatura trapezoidale mm	Traversino mm	Filettatura trapezoidale mm	Traversino mm		
SPZ60K	27 x 13	18 x 5	10 x 120				
No. d'ordine	3101338	3100398		-		3101194*	3101188
SPZ80K	30 x 15	20 x 5	11 x 120	20 x 5	11 x 120		
No. d'ordine	3101330	3100399		3101815		-	-

Strettoio per tetti SPZ80K

	Piastra di pressione standard ad alta prestazione		Piastra di pressione ad alta prestazione con superficie ruvida		Piastra di pressione ad alta prestazione con scanalatura V	
						
	Foro per fuso mm	Perno di pressione mm	Foro per fuso mm	Perno di pressione mm	Foro per fuso mm	Perno di pressione mm
SPZ80K	12	5 x 20	12	5 x 20	12	5 x 20
No. d'ordine	3100736		3101192		3101193	



BESSEY Lista per accessori e pezzi di ricambio 2025/2026**Pinze grip GRZ**

	Cappuccio protettivo per GRZ10 e GRZ20	Cappuccio protettivo per GRZRO
		
	4 Pz.	2 Paia
GRZ10 – GRZ20		
No. d'ordine	3100576	-
GRZRO		
No. d'ordine	-	3101547

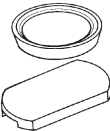

KliKlamp KLI

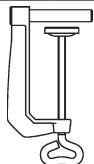
	Guaina per ganascia fissa e mobile	
		
	10 Paia	
	per Ø mm	per larghezza mm
KLI	25,5	23
No. d'ordine	3101393	

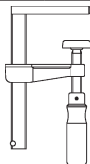
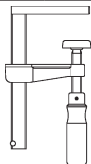
Strettoio a vite S10 / Morsa per serraggio in squadra WS

	Morsetto da tavolo		Morsetto da tavolo		Morsetto da tavolo		Morsetto da tavolo	
								
	Ø 8 mm		Ø 8 mm		Ø 8 mm		Ø 8 mm	
	Apertura mm	Scarta- mento mm	Apertura mm	Scarta- mento mm	Apertura mm	Scarta- mento mm	Apertura mm	Scarta- mento mm
S10-ST / WS3	60	22	60	28	100	50	150	50
No. d'ordine	TK6		RB269		LM10/5R8		LM15/5R8	

Morsetto da banco utilizzabile con una sola mano EZR

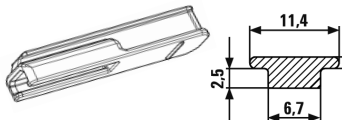
	Set di cappucci protettivi	Dispositivo di fissaggio	Adattatore per binari di guida (Bosch, Mafell)
			
	10 Pz.	2 Pz.	2 Pz.
EZR			
No. d'ordine	3101959	3101962	3102016

Morsetto da banco in acciaio puro GTR

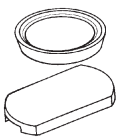
	Guaina per ganascia fissa e mobile	
		
	10 Paia	
	per Ø mm	per larghezza mm
GTR	22	17
No. d'ordine	3101391	

BESSEY Lista per accessori e pezzi di ricambio 2025/2026**Strettoi a nastro BAN**

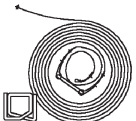
Ricambio per nastro/ prolunga	
	
BAN700 / SVH	nastro 7100 lg, 2 fibbie
No. d'ordine	3100832

Strettoio per bordi utilizzabile con una sola mano EKT

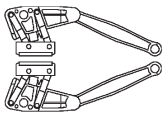
	Set di ricambio composto	Ganasce complete con biella
		
	3 pz. cappucci protettivi e 6 pz. di ganasce	2 Paia
EKT55		
No. d'ordine	3101403	3100998

Strettoio per bordi KT

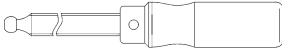
	Fuso cpl.
	
KT5-1	
No. d'ordine	3101799

Kantenfix KF e portapiastre KFP

Ganasce di pressione	
 <p>1 paio molla incl.</p>	
KF2	
No. d'ordine	4102100
KF4	
No. d'ordine	4102056
KFP	
No. d'ordine	4102057*

* adatto per KFP dal 2018 (rosso ganasce di pressione)



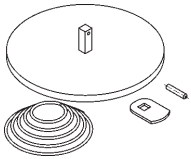
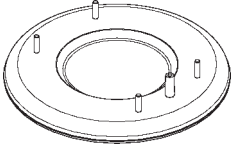
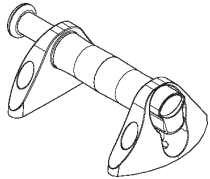

Aggraffatore PS

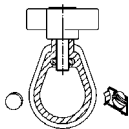
	Adattatore aspirante per posa	Gomma	Impugnatura
			
	Ø mm	Ø mm	
PS55	120		
No. d'ordine	3101839	-	-
PS130		210	
No. d'ordine	-	3101685	3101686

BESSEY Lista per accessori e pezzi di ricambio 2025/2026**Puntello per il montaggio di telai porte TMS**

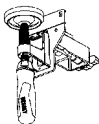
	Pezzo di serraggio
	
TMS	
No. d'ordine	3100983

Puntello per telai porte TU

	Asta di serraggio compl. incl. pezzo di scorrimento	Bracci estraibili	Prolunga	Feltro	Tasca
					
				4 Pz.	
TU					
No. d'ordine	3101752	3101764	TUX	3101632	3101762

Strettoio per allineamento die telai porte TFM

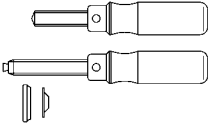
	2 x fuso con piastra di pressione sciolta e cappuccio protettivo
	
TFM	
No. d'ordine	3101408

Strettoio per finestre FRK

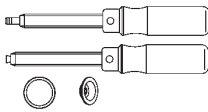
2 x fuso con piastra di pressione sciolta e cappuccio protettivo	
	
FRK	
No. d'ordine	3101409



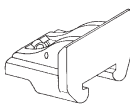
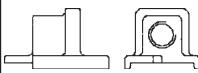
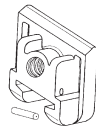
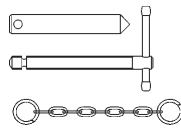

Tenditore per porte TB

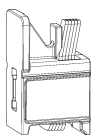
	Ganasce di pressione		Inserimento per fuso	Ganasce di serraggio	Set di fusi TB
					
	Larghezza ganasce mm	Altezza ganasce mm	Filettature trapezoidale mm		
TB	60 (80)	48	18 x 5		
No. d'ordine	3101793		3101792	3100920	3101405



Tenditore per porte TL

Ganasce di pressione	
	
TL	
No. d'ordine	3101877



BESSEY Lista per accessori e pezzi di ricambio 2025/2026**Telescopica di supporto STE, ST**

	Supporto multi- funzione/laser	Piastra di supporto	Supporto da soffitto	Treppiede professionale	Borsa combinata
					
STE					
No. d'ordine	STE-LH	STE-SP35	STE-DS	STE-BS	-
ST					
No. d'ordine	STE-LH	STE-SP35	STE-DS	STE-BS	-
STE300 STE370					
No. d'ordine	-	-	-	-	STE-BAG

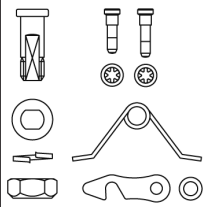
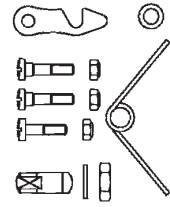
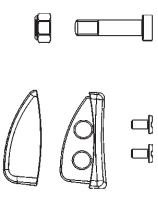

Telescopica di supporto STE, ST

	Superficie di contatto di ricambio	Capocorda di bloccaggio	Vite di presa a stella
			 4 Pz.
STE			
No. d'ordine	3101952	-	-
ST			
No. d'ordine	3101952	3101969	-
STE-SP35			
No. d'ordine	-	-	3101970

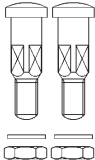
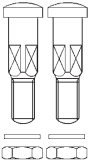
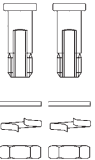

BESSEY Lista per accessori e pezzi di ricambio 2025/2026**Cesoie per lamiera a leva**

	Set da riparazione 08/22A 27/29/123S	Set da riparazione 17A-2	Preso bassa completa 123S	Borsa avvolgibile
				 per la 3 cesoie
D08 ... D16A D22A D27AH-TIN/L				
No. d'ordine	R032	-	-	7002464
D16 / D16L / D16S				
No. d'ordine	-	-	-	7002464
D27 ... D29 ...				
No. d'ordine	R001	-	-	7002464
D17A-2/L				
No. d'ordine	-	R043	-	7002464
D123S				
No. d'ordine	R001	-	R042	7002464

Cesioie per lamiere normali

	Avvitamento completo M6 D8 x 24	Avvitamento completo M6 D8 x 26	Avvitamento completo M8 x1 x 22	Borsa avvolgibile
				
	2 Pz.	2 Pz.	2 Pz.	per la 3 cesioie
D101-200 - D101-250 D201-200 - D201-250 D102-225 D202-225 D107-225 - D107-275 D207-225 - D207-275 D114-250 - D114-275 D214-250 - D214-275 D159-200 - D159-250				
No. d'ordine	R034	-	-	7002464
D102-250 - D102-300 D202-250 - D202-300 D106-250 D106A-250 D107-300 - D107-350 D207-300 - D207-350 D208-275 D209-275 D114-300 D214-300 D159-300 - D159-350				
No. d'ordine	-	R035	-	7002464
D116-260 - D116-280 D216-260 - D216-280 D216-260-B-SBSK D216-280-B-SBSK D118-300 - D118-350 D218-300 - D218-350 D416-280 D 418-300 - D418-350				
No. d'ordine	-	-	R036	7002464
D407-275 - D407-300				
No. d'ordine	-	-	-	7002464

Coltello con lama ripieghevole nel manico

	Lame trapezoidali	Lame ad uncino	Lame per linoleum
	 10 Pz.	 10 Pz.	 5 Pz.
DBKPH DBKWH DBKAH			
No. d'ordine	DBK-T	DBK-H	DBK-L

BESSEY
 Imagefilm

 BESSEY Tool GmbH & Co. KG ■ Mühlwiesenstraße 40
 74321 Bietigheim-Bissingen, Germany
 Fon +49 7142 401-0 ■ Fax: +49 7142 401-452
 E-Mail: tool-info@bessey.de

 Il vostro rivenditore: