

















## BESSEY Liste over tilbehør og reservedele 2024/2025

4-7	<b>Blødstøtte skruetvinger</b>	17	<b>Gribearmstvinger</b>	23	<b>Korpusspænder</b>
	TG / TPN TGK / TKPN TGNT		GRA...12		KS
8-11	<b>Helsmedede stålskruetvinger</b>	17	<b>Variable hurtigspændere</b>	23	<b>Planspænder</b>
	GZ / GS G...Z GU25-12-6ZK GMZ		STC-VH / STC-HH STC-HV / STC-HA STC-IHH / STC-IHA TW..A-STC TW..VAD / TWVAD		FK
12-13	<b>Hurtigtvinger</b>	18-20	<b>Spændeelementer til svejseborde</b>	23	<b>Geartvinge GearKlamp</b>
	GH / GSH GHS / G...H		TWV / TW TWM28 TW28GRS WNS-SET-MFT		GK
14-15	<b>Kraftige helsmedede stålskruetvinger</b>	21	<b>Maskinbordspændere</b>	24	<b>Enhåndstvinger</b>
	SLM / SGM / SGL SG...M / STBM STBS / STBVC SGU / STBU GSL / GSM		BAS BSN SGHS		EHZ / EZS / EZ
16	<b>Variable skruetvinger</b>	22	<b>Korpustvinger</b>	25	<b>Spærtvinger</b>
	SLV / GSV		KRE / KREV KR / KRV / K		SPZ

**26 Griptænger**



GRZ  
GRZRO

**26 Hightech-hurtigtvinge KliKlamp**



KLI

**27 Skruestik og vinkelspænder**



S10 / WS

**27 Bordklemme**



EZR / GTR

**28 Båndspændere**



BAN

**29 Kanttvinger og pladestativ**



EKT  
KT5-1  
KF / KFP

**29 Pladespænder**



PS

**30-32 Dørkarms- og vinduesmonteringsværktøj**



TMS / TU / TFM / FRK



TAN / TB / TL

**32-33 Lofts- og teleskopstøtter**



STE / ST

**34 Håndpladesakse med udveksling**



**35 Håndpladesakse i normal udførelse**



**36 Blik nibler og hobbyknive**



BESSEY produktudvikling forbeholder sig ret til tekniske ændringer. Med forbehold for trykfejl.

## BESSEY Liste over tilbehør og reservedele 2024/2025



### Blødstøbe skruetvinger

egnet til serie TG og TPN (HIT tvinger)

	Underdel kpl. med 2-komponent kunststofgreb		2-komponent kunststofgreb inkl. udskiftelig tryksko af kvalitetsstål med beskyttelseskappe			Underdel kpl. med trægreb		Trægreb inkl. udskiftelig tryksko af kvalitetsstål med beskyttelseskappe		
	Udladning mm	til skinne mm	Længde x Ø mm	Hoved Ø mm	Trapezformet gevind mm	Udladning mm	til skinne mm	Længde x Ø mm	Hoved Ø mm	Trapezformet gevind mm
<b>TG10 / TG...B5</b>										
Bestill.-nr.	-			-		-			-	
<b>TG12 / TG...B6</b>										
Bestill.-nr.	-			-		-			-	
<b>TG 16 TG...B8 TPN 16 TPN...B8</b>			110 x 30	10	14 x 4					
Bestill.-nr.	-		3101179			-			-	
<b>TG 20 TG...S10 TPN 20 TPN...S10</b>			110 x 30	12	16 x 4	100	27 x 7	112 x 30	12	16 x 4
Bestill.-nr.	-		3101182			3101413		3101386		
<b>TG 25 TG...S12 TPN 25 TPN...S12</b>	120	29 x 9	130 x 34	12	16 x 4	120	29 x 9	125 x 32	12	16 x 4
Bestill.-nr.	3101832		3101186			3101414		3101389		
<b>TG 30 TG...S14 TPN 30 TPN...S14</b>	140	32 x 10	130 x 34	13	18 x 5	140	32 x 10	140 x 35	13	18 x 5
Bestill.-nr.	3101833		3101187			3101415		3101390		
<b>TG 40 TG...S17</b>	175	32 x 10	130 x 34	13	18 x 5	175	32 x 10	140 x 35	13	18 x 5
Bestill.-nr.	3101834		3101187			3101416		3101390		
<b>TPN 40 TPN...S17</b>	175	32 x 10	130 x 34	13	18 x 5	175	32 x 10	140 x 35	13	18 x 5
Bestill.-nr.	3101834		3101187			3101416		3101390		

## Blødstøbte skruevinger

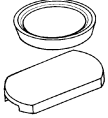
egnet til serie TG og TPN (HIT tvinger)

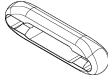
	Udskiftelig tryksko med beskyttelseskappe fra størrelse 16 og opefter	Beskyttelseskapper til over- og underdel		Aflange beskyttelseskapper SKS	Knebel tilbehør KA
					
	4 par	10 par		2 stk.	2 stk.
	Ø mm	til Ø mm	til bredde (overdel) mm		kun til knebelgreb-varianter egnet
<b>TG10 / TG...B5</b>	22	22	17		
Bestill.-nr.	3101339	3101391		-	-
<b>TG12 / TG...B6</b>	22	22	19		
Bestill.-nr.	3101339	3101392		-	-
<b>TG 16 TG...B8 TPN 16 TPN...B8</b>	25,5	25,5	23		
Bestill.-nr.	3101180	3101393		-	-
<b>TG 20 TG...S10 TPN 20 TPN...S10</b>	32	32	28		
Bestill.-nr.	3101183	3101394		-	3101194*
<b>TG 25 TG...S12 TPN 25 TPN...S12</b>	32	32	30		
Bestill.-nr.	3101183	3101395		-	3101194*
<b>TG 30 TG...S14 TPN 30 TPN...S14</b>	38,5	38,5	32		
Bestill.-nr.	3101188	3101396		-	3101194*
<b>TG 40 TG...S17</b>	38,5	38,5	32		
Bestill.-nr.	3101188	3101396		-	3101194*
<b>TPN 40 TPN...S17</b>	38,5				
Bestill.-nr.	3101188	-		SKS20/40	3101194*

\*Kan leveres så længe lager haves

## BESSEY Liste over tilbehør og reservedele 2024/2025

### Blødstøbte skruetvinger

egnet til serie TGK og TKPN

	Underdel kpl. med 2-komponent kunststofgreb		2-komponent kunststofgreb med tryksko af kvalitetsstål med beskyttelseskappe			Underdel kpl. med trægreb		Trægreb inkl. udskiftelig tryksko af kvalitetsstål med beskyttelseskappe		
	Udladning mm	til skinne mm	Længde x Ø mm	Hoved Ø mm	Trapezformet gevind mm	Udladning mm	til skinne mm	Længde x Ø mm	Hoved Ø mm	Trapezformet gevind mm
<b>TGK TKPN</b>	120	35 x 11	130 x 34	13	18 x 5	120	35 x 11	140 x 35	13	18 x 5
<b>Bestill.-nr.</b>	3101838		3101187			3101417		3101390		



### Blødstøbte skruetvinger

egnet til serie TGK og TKPN

	Knebelgreb		Tryksko med beskyttelseskappe	Aflange beskyttelseskapper SKS		Knebel tilbehør KA
	Udladning mm	til skinne mm	Ø mm	til Ø mm	til bredde (overdel) mm	kun til knebelgreb-varianter egnet
<b>TGK TKPN</b>			38,5	25,5	23	
<b>Bestill.-nr.</b>	-		3101188	SKS20/40		3101194*
<b>TGK-K</b>	120	35 x 11	38,5	25,5	23	
<b>Bestill.-nr.</b>	3101418		3101188	SKS20/40		3101194*

## Skruevinge med stor udladning

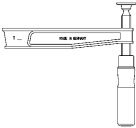
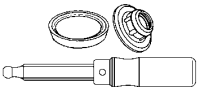
egnet til serie TGN

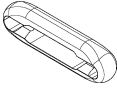
	Underdel kpl. med trægreb		Trægreb med tryksko af kvalitetsstål med beskyttelseskappe			Tryksko med beskyttelseskappe	Knebel tilbehør KA
							
						4 par	2 stk.
	Udladning mm	til skinne mm	Længde x Ø mm	Hoved Ø mm	Trapezformet gevind mm	Ø mm	kun til knebelgreb-varianter egnet
<b>TGN...T20</b>	200	35 x 11	140 x 35	13	18 x 5	38,5	
<b>Bestill.-nr.</b>	3101419		3101390			3101188	3101194*
<b>TGN...T25</b>	250	40 x 11	140 x 35	13	18 x 5	38,5	
<b>Bestill.-nr.</b>	3101420		3101390			3101188	3101194*
<b>TGN...T30</b>	300	45 x 12	140 x 35	13	18 x 5	38,5	
<b>Bestill.-nr.</b>	3101421		3101390			3101188	3101194*
<b>TGN...T40</b>			140 x 35	13	18 x 5	38,5	
<b>Bestill.-nr.</b>	-		3101390			3101188	3101194*
<b>TGN...T50</b>			140 x 35	13	18 x 5	38,5	
<b>Bestill.-nr.</b>	-		3101390			3101188	3101194*

\*Kan leveres så længe lager haves

## BESSEY Liste over tilbehør og reservedele 2024/2025

### Helsmedede stålskruetvinger – ny version fra 01.07.09



egnet til serie GZ

	Glidebøjle kpl. med 2-komponent kunststofgreb		2-komponent kunststofgreb med tryksko af kvalitetsstål med beskyttelseskappe			Glidebøjle kpl. med trægreb		Trægreb inkl. udskiftelig tryksko af kvalitetsstål med beskyttelseskappe		
	Udladning mm	til skinne mm	Længde x Ø mm	Hoved Ø mm	Trapezformet gevind mm	Udladning mm	til skinne mm	Længde x Ø mm	Hoved Ø mm	Trapezformet gevind mm
<b>GZ 10 / GZ 12</b>										
Bestill.-nr.	-		-			-		-		
<b>GZ 16</b>			110 x 30	10	14 x 4					
Bestill.-nr.	-		3101179			-		-		
<b>GZ 20 GZ...-10</b>	100	22 x 8,5	110 x 30	12	16 x 4	100	22 x 8,5	112 x 30	12	16 x 4
Bestill.-nr.	3101955		3101182			3101516		3101386		
<b>GZ 25 GZ...-12</b>	120	24 x 9,5	130 x 34	12	16 x 4	120	24 x 9,5	125 x 32	12	16 x 4
Bestill.-nr.	3101835		3101186			3101517		3101389		
<b>GZ 30</b>	140	28 x 11	130 x 34	13	18 x 5	140	28 x 11	140 x 35	13	18 x 5
Bestill.-nr.	3101836		3101187			3101518		3101390		
<b>GZ 40 - GZ 125</b>	120	28 x 11	130 x 34	13	18 x 5	120	28 x 11	140 x 35	13	18 x 5
Bestill.-nr.	3101837		3101187			3101519		3101390		

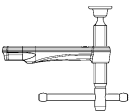
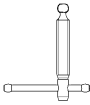

## Helsmedede stålskruetvinger – ny version fra 01.07.09

egnet til serie GZ

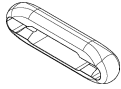
Glidebøjle kpl. med knebelgreb		Knebelgreb	2-komponent kunststof-klapgreb med tryksko af kvalitetsstål med beskyttelseskappe			Udskiftelig tryksko med beskyttelseskappe fra størrelse 16 og opefter	Knebel tilbehør KA
							
Udladning mm	til skinne mm	Trapezformet gevind mm	Længde x Ø mm	Hoved Ø mm	Trapezformet gevind mm	Ø mm	kun til knebelgreb-varianter egnet
<b>GZ 10 / GZ 12</b>						22	
Bestill.-nr.	-	-	-			3101339	-
<b>GZ 16</b>		14 x 4				25,5	
Bestill.-nr.	-	3101795	-			3101180	-
<b>GZ 20 GZ...-10</b>	100   22 x 8,5	16 x 4				32	
Bestill.-nr.	3101441	3101796	-			3101183	3101194*
<b>GZ 25 GZ...-12</b>	120   24 x 9,5	16 x 4	125 x 35	12	16 x 4	32	
Bestill.-nr.	3101444	3101796	3101958			3101183	3101194*
<b>GZ 30</b>	140   28 x 11	18 x 5				38,5	
Bestill.-nr.	3101447	3101797	-			3101188	3101194*
<b>GZ 40 - GZ 125</b>	120   28 x 11	18 x 5				38,5	
Bestill.-nr.	3101450	3101797	-			3101188	3101194*

\*Kan leveres så længe lager haves

## BESSEY Liste over tilbehør og reservedele 2024/2025



### OMEGA skruevinger og helsmedede classiX stålskruevinger og helsmedede stålskruevinger – gamle version indtil 30.06.09

egnet til serie GMZ, G...Z, GS

	Glidebøjle kpl. med trægreb		Glidebøjle kpl. med knebelgreb		Trægreb inkl. udskiftelig tryksko af kvalitetsstål med beskyttelseskappe			2-komponent kunststofgreb med tryksko af kvalitetsstål med beskyttelseskappe		
	Udladning mm	til skinne mm	Udladning mm	til skinne mm	Længde x Ø mm	Hoved Ø mm	Trapezformet gevind mm	Længde x Ø mm	Hoved Ø mm	Trapezformet gevind mm
<b>G10Z / G12Z GS10 / GS12</b>										
<b>Bestill.-nr.</b>	-		-		-			-		
<b>G16Z / GS16</b>								110 x 30	10	14 x 4
<b>Bestill.-nr.</b>	-		-		-			3101179		
<b>G20Z/G...-S10Z GS20 GM 20Z GM...S10Z</b>	100	19,5 x 9,5	100	19,5 x 9,5	112 x 30	12	16 x 4	110 x 30	12	16 x 4
<b>Bestill.-nr.</b>	3101422		3101800		3101386			3101182		
<b>G25Z/G...-S12Z GS25 GM 25Z GM...-S12Z GU25-12-6ZK</b>	120	22 x 10,5	120	22 x 10,5	125 x 32	12	16 x 4	130 x 34	12	16 x 4
<b>Bestill.-nr.</b>	3101423		3101801		3101389			3101186		
<b>G30Z / GS30 GM30Z</b>	140	25 x 12	140	25 x 12	140 x 35	13	18 x 5	130 x 34	13	18 x 5
<b>Bestill.-nr.</b>	3101424		3101802		3101390			3101187		
<b>G40Z-G60Z GS40-GS60 GM40Z-GM60Z</b>	120	25 x 12	120	25 x 12	140 x 35	13	18 x 5	130 x 34	13	18 x 5
<b>Bestill.-nr.</b>	3101425		3101803		3101390			3101187		
<b>G80Z-G125Z GS80-GS100 GM80Z-GM125Z</b>	120	27 x 13	120	27 x 13	140 x 35	13	18 x 5	130 x 34	13	18 x 5
<b>Bestill.-nr.</b>	3101426		3101804		3101390			3101187		

# OMEGA skruevinger og helsmedede classiX stålskruevinger og helsmedede stålskruevinger – gamle version indtil 30.06.09

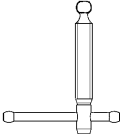
egnet til serie GMZ, G...Z, GS

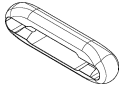
	Knebelgreb	Udskiftelig tryksko med beskyttelseskappe fra størrelse 16 og opefter	Knebel tilbehør KA
			
		4 par	2 stk.
	Trapezformet gevind mm	Ø mm	kun til knebelgreb-varianter egnet
<b>G10Z / G12Z GS10 / GS12</b>		22	
<b>Bestill.-nr.</b>	-	<b>3101339</b>	-
<b>G16Z / GS16</b>	14 x 4	25,5	
<b>Bestill.-nr.</b>	<b>3101795</b>	<b>3101180</b>	-
<b>G20Z/G...S10Z GS20 GM 20Z GM...S10Z</b>	16 x 4	32	
<b>Bestill.-nr.</b>	<b>3101796</b>	<b>3101183</b>	<b>3101194*</b>
<b>G25Z/G...S12Z GS25 GM 25Z GM...S12Z GU25-12-6ZK</b>	16 x 4	32	
<b>Bestill.-nr.</b>	<b>3101796</b>	<b>3101183</b>	<b>3101194*</b>
<b>G30Z / GS30 GM30Z</b>	18 x 5	38,5	
<b>Bestill.-nr.</b>	<b>3101797</b>	<b>3101188</b>	<b>3101194*</b>
<b>G40Z-G60Z GS40-GS60 GM40Z-GM60Z</b>	18 x 5	38,5	
<b>Bestill.-nr.</b>	<b>3101797</b>	<b>3101188</b>	<b>3101194*</b>
<b>G80Z-G125Z GS80-GS100 GM80Z-GM125Z</b>	18 x 5	38,5	
<b>Bestill.-nr.</b>	<b>3101797</b>	<b>3101188</b>	<b>3101194*</b>

\*Kan leveres så længe lager haves

## BESSEY Liste over tilbehør og reservedele 2024/2025

### Hurtigtvinger – GH – ny version fra 01.03.10

egnet til serie GH

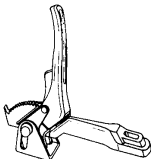
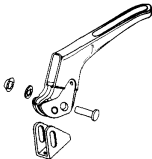
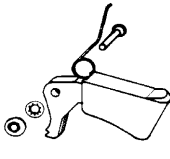
	Glidebøjle kpl.		Håndtag med tryksko kpl.	Udløser kpl.
				
	Udladning mm	til skinne mm	Bolt Ø x længde mm	Bolt Ø x længde mm
<b>GH 12 GH 16</b>				5h11 x 21
<b>Bestill.-nr.</b>	-		-	<b>3101399</b>
<b>GH 20 GH...-10</b>	100	22 x 8,5	10 x 33,5	5h11 x 23
<b>Bestill.-nr.</b>	<b>3101522</b>		<b>3101397</b>	<b>3101400</b>
<b>GH 25 GH...-12</b>	120	24,5 x 9,5	10 x 33,5	5h11 x 23
<b>Bestill.-nr.</b>	<b>3101523</b>		<b>3101397</b>	<b>3101400</b>
<b>GH 30</b>	140	28 x 11	12 x 38	5h11 x 26
<b>Bestill.-nr.</b>	<b>3101524</b>		<b>3101398</b>	<b>3101401</b>
<b>GH 40 - GH 100</b>	120	28 x 11	12 x 38	5h11 x 26
<b>Bestill.-nr.</b>	<b>3101525</b>		<b>3101398</b>	<b>3101401</b>

## Hurtigtvinger classiX – GSH

### og hurtigtvinger – GH – gamle version indtil 28.02.10

egnet til serie G...H, GSH

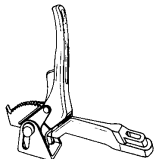
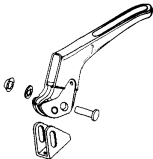
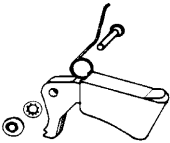

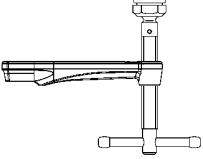
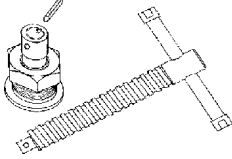
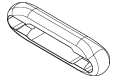

	Glidebøjle kpl.		Håndtag med tryksko kpl.	Udløser kpl.
				 2 stk.
	Udladning mm	til skinne mm	Bolt Ø x længde mm	Bolt Ø x længde mm
<b>G12H / G...S6H G16H / G...S8H GSH12 - GSH16</b>				5h11 x 21
<b>Bestill.-nr.</b>	-		-	<b>3101399</b>
<b>G20H / G...S10H GSH20</b>	100	19,5 x 9,5	10 x 33,5	5h11 x 23
<b>Bestill.-nr.</b>	<b>3101333</b>		<b>3101397</b>	<b>3101400</b>
<b>G25H / G...S12H GSH25 GU-H</b>	120	22 x 10,5	10 x 33,5	5h11 x 23
<b>Bestill.-nr.</b>	<b>3101334</b>		<b>3101397</b>	<b>3101400</b>
<b>G30H GSH30</b>	140	25 x 12	12 x 38	5h11 x 26
<b>Bestill.-nr.</b>	<b>3101335</b>		<b>3101398</b>	<b>3101401</b>
<b>G40H - G60H GSH40 - GSH60</b>	120	25 x 12	12 x 38	5h11 x 26
<b>Bestill.-nr.</b>	<b>3101336</b>		<b>3101398</b>	<b>3101401</b>
<b>G80H - G100H</b>	120	27 x 13	12 x 38	5h11 x 26
<b>Bestill.-nr.</b>	<b>3101337</b>		<b>3101398</b>	<b>3101401</b>

## BESSEY Liste over tilbehør og reservedele 2024/2025

### Kraftige helsmedede stålskruetvinger – SLM og SGM – ny version fra 01.07.08

	Glidebøjle kpl.		Kombisæt (spindel + særlig trykplade + spændstift)		Knebel tilbehør KA
	Udladning mm	til skinne mm	Trapezformet gevind mm	Knebel Ø x længde mm	
					 2 stk.
<b>SL...M</b>	120	28 x 11	18 x 5	10 x 120	
Bestill.-nr.	3101521		3100398		3101194*
<b>SG...M</b>	140	34 x 13	20 x 5	11 x 120	
Bestill.-nr.	3101407		3100399		-

### Kraftige helsmedede stålskruetvinger – SLM/SGM/STBM/STBVC/SGU/STBU/STBS

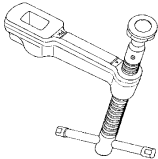
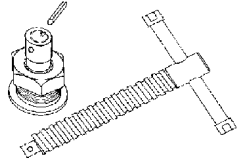
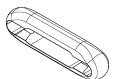

	Specialtryksko standard		Specialtryksko med riller		Specialtryksko med prisme		Skruøbøs- ning med sikring	Kile STBS
	Spindel- boring mm	Spænde- stift mm	Spindel- boring mm	Spænde- stift mm	Spindel- boring mm	Spænde- stift mm	Gevind	
								 2 stk.
<b>SLM / SGM STBM / STBVC SGU</b>	12	5 x 20	12	5 x 20	12	5 x 20		
Bestill.-nr.	3100736		3101192		3101193		-	-
<b>STBU</b>	12	5 x 20	12	5 x 20	12	5 x 20		
Bestill.-nr.	3100737		3101192		3101193		-	-
<b>STBS</b>	12	5 x 20					M 24	
Bestill.-nr.	3100737		-		-		3100579	3101788

## Kraftige helsmedede stålskruetvinger classiX – GSL og GSM og kraftige helsmedede stålskruetvinger – SGL og SGM – gamle version indtil 30.06.08



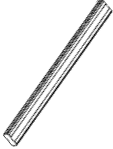
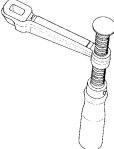
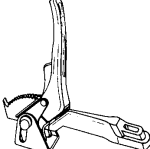
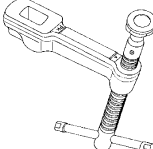

	Glidebøjle kpl.		Kombisæt (spindel + særlig trykplade + spændstift)		Knebel tilbehør KA
					
	Udladning mm	til skinne mm	Trapezformet gevind mm	Knebel Ø x længde mm	2 stk.
<b>SGL...M / GSL</b>	120	27 x 13	18 x 5	10 x 120	
<b>Bestill.-nr.</b>	<b>3101338</b>		<b>3100398</b>		<b>3101194*</b>
<b>SG...M</b>	120	30 x 15	20 x 5	11 x 120	
<b>Bestill.-nr.</b>	<b>3101329</b>		<b>3100399</b>		-
<b>SG30M / GSM / SGU</b>	140	30 x 15	20 x 5	11 x 120	
<b>Bestill.-nr.</b>	<b>3101330</b>		<b>3100399</b>		-
<b>SG..T20M</b>	200	30 x 15	20 x 5	11 x 120	
<b>Bestill.-nr.</b>	<b>3101331</b>		<b>3100399</b>		-
<b>STB...M/STBU</b>	175	40 x 20	22 x 5	11 x 180	
<b>Bestill.-nr.</b>	<b>3101332</b>		<b>3100400</b>		-
<b>STBS</b>	200	50 x 25	M24	18 x 345	
<b>Bestill.-nr.</b>	<b>3101798</b>		<b>3100401</b>		-
<b>STBVC</b>	100	40 x 20	22 x 5	11 x 180	
<b>Bestill.-nr.</b>	<b>3101882</b>		<b>3100400</b>		-

## BESSEY Liste over tilbehør og reservedele 2024/2025

### Variable kraftige helsmedede stålskruetvinger SLV, GSV

	Skinne med 2 endesikring		Glidebøjle kpl. med trægreb		Glidebøjle kpl. med spændearm		Glidebøjle kpl. med knebelgreb		Knebel tilbehør KA
									 2 stk.
	Spændvidde mm	Skinne mm	Udladning mm	til skinne mm	Udladning mm	til skinne mm	Udladning mm	til skinne mm	kun til knebelgreb-varianten egnet
<b>SLV</b>	1000	27 x 13	120	27 x 13	120	27 x 13	120	27 x 13	
Bestill.-nr.	3101731		3101426		3101337		3101338		3101194*
<b>SLV</b>	1500	27 x 13	120	27 x 13	120	27 x 13	120	27 x 13	
Bestill.-nr.	3101732		3101426		3101337		3101338		3101194*
<b>SLV</b>	2000	27 x 13	120	27 x 13	120	27 x 13	120	27 x 13	
Bestill.-nr.	3101733		3101426		3101337		3101338		3101194*

<b>GSV</b>	3000	30 x 15					120	30 x 15	
Bestill.-nr.	3101612		-		-		3101329		-
<b>GSV</b>	3000	30 x 15					140	30 x 15	
Bestill.-nr.	3101612		-		-		3101330		-
<b>GSV</b>	3000	30 x 15					200	30 x 15	
Bestill.-nr.	3101612		-		-		3101331		



	Specialtryksko standard		Specialtryksko med riller		Specialtryksko med prisme		Endesikring
							 2 par
	Spindelboring mm	Spændestift mm	Spindelboring mm	Spændestift mm	Spindelboring mm	Spændestift mm	
<b>SLV / GSV</b>	12	5 x 20	12	5 x 20	12	5 x 20	
Bestill.-nr.	3100736		3101192		3101193		3101782

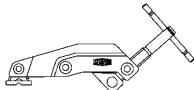
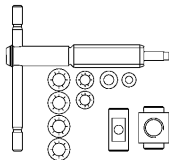

## Gribearmstvinger – ny version fra 01.04.12

	Gribearms kpl.		Skruer kpl.	
				
	Udladning mm	til skinne mm	Trapezformet gevind mm	Knebel $\varnothing$ x længde mm
<b>GRA...12</b>	120	28 x 11	18 x 5	8 x 110
<b>Bestill.-nr.</b>	3101590		3100562	

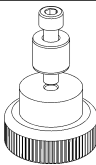
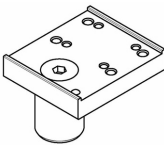
## Variable hurtigspændere STC

	Skruesæt kpl.	Til multifunktionsborde adapter	Til værktøjsbænke			
			maskinbordspænderadapter		forlænger	
		 1 cylinderskrue DIN 912 M 8 x 35 1 stikbolt D20 x 17 1 fingermøtrik M8				
			Hul $\varnothing$	Hul $\varnothing$	Hul $\varnothing$	Korrektions- vandrind
<b>STC-VH20 / STC-HH20 STC-IHH 15</b>			16	28		
<b>Bestill.-nr.</b>	3101627	-	TW16A-STC	TW28A-STC	-	
<b>STC-HV20 / STC-HA20 STC-IHA 15</b>						
<b>Bestill.-nr.</b>	3101627	-	-	-	-	
<b>STC-VH50 / STC-HH 50 STC-IHH 25</b>			16	28		
<b>Bestill.-nr.</b>	3101589	STC-SET-T20	TW16A-STC	TW28A-STC	-	
<b>STC-HH 70</b>			16	28		
<b>Bestill.-nr.</b>	3101588	STC-SET-T20	TW16A-STC	TW28A-STC	-	
<b>TW16A-STC TW16VAD / TWVAD</b>					16	15-200
<b>Bestill.-nr.</b>	-	-	-	-	TW16X	
<b>TW28A-STC TW28VAD / TWVAD</b>					28	15-300
<b>Bestill.-nr.</b>	-	-	-	-	TW28X	

## BESSEY Liste over tilbehør og reservedele 2024/2025

### Spændeelementer med variabel udladning TWV

	Skinne		Kryds spænder kpl.	Glidebøjle kpl. med 2-komponent kunststofgreb		Glidebøjle kpl. med knebelgreb		Glidebøjle kpl. med spændearm		Adapter til værktøjs-bænk
	Spændvidde mm	Skinne mm	til skinne mm	Udladning mm	til skinne mm	Udladning mm	til skinne mm	Udladning mm	til skinne mm	egnet til
<b>TWV16</b>	200	22 x 8,5	22 x 8,5	30-150	22 x 8,5	30-150	22 x 8,5	60-150	22 x 8,5	19 mm/3/4"
Bestill.-nr.	3101740		3101744	3101741		3101742		3101743		TW16AW19
<b>TWV16</b>	200	22 x 8,5	22 x 8,5	30-150	22 x 8,5	30-150	22 x 8,5	60-150	22 x 8,5	20 mm/13/16"
Bestill.-nr.	3101740		3101744	3101741		3101742		3101743		TW16AW20
<b>TWV16</b>	200	22 x 8,5	22 x 8,5	30-150	22 x 8,5	30-150	22 x 8,5	60-150	22 x 8,5	-
Bestill.-nr.	3101740		3101744	3101741		3101742		3101743		-
<b>TWV16</b>	200	22 x 8,5	22 x 8,5	30-150	22 x 8,5	30-150	22 x 8,5	60-150	22 x 8,5	30 mm/1 3/16"
Bestill.-nr.	3101740		3101744	3101741		3101742		3101743		TW16AW30
<b>TWV28</b>	300	28 x 11	28 x 11	40-175	28 x 11	40-175	28 x 11	110-175	28 x 11	-
Bestill.-nr.	3101706		3101710	3101707		3101708		3101709		-

### Vandret nedtræks-spændeanordning til multifunktionsborde WNS-SET-MFT

Bænkager til multifunktionsborde	
 <p>4 bænkager 4 fingermøtrik</p>	
Bolt Ø mm	
<b>WNS-SET-MFT</b>	20
Bestill.-nr.	BH-MFT

## Spændeelementer med en fast udladning TW

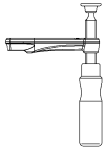
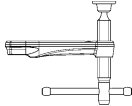
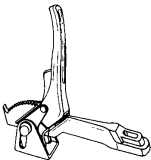
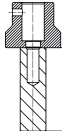
	Skinne		Glidebøjle kpl. med trægreb		Glidebøjle kpl. med knebelgreb		Glidebøjle kpl. med spændearm		Adapter til værktøjsbænk
									
	Spændvidde mm	Skinne mm	Udladning mm	til skinne mm	Udladning mm	til skinne mm	Udladning mm	til skinne mm	egnet til
<b>TW16</b>	200	22 x 8,5	100	22 x 8,5	100	22 x 8,5	100	22 x 8,5	19 mm/3/4"
Bestill.-nr.	3101740		3101516		3101441		3101522		TW16AW19
<b>TW16</b>	200	22 x 8,5	100	22 x 8,5	100	22 x 8,5	100	22 x 8,5	20 mm/13/16"
Bestill.-nr.	3101740		3101516		3101441		3101522		TW16AW20
<b>TW16</b>	200	22 x 8,5	100	22 x 8,5	100	22 x 8,5	100	22 x 8,5	-
Bestill.-nr.	3101740		3101516		3101441		3101522		-
<b>TW16</b>	200	22 x 8,5	100	22 x 8,5	100	22 x 8,5	100	22 x 8,5	30 mm/1 3/16"
Bestill.-nr.	3101740		3101516		3101441		3101522		TW16AW30
<b>TW28</b>	300	28 x 11	120	28 x 11	120	28 x 11	120	28 x 11	-
Bestill.-nr.	3101706		3101519		3101450		3101525		-
<b>TW28</b>	300	28 x 11	140	28 x 11	140	28 x 11	140	28 x 11	-
Bestill.-nr.	3101706		3101518		3101447		3101524		-

## BESSEY Liste over tilbehør og reservedele 2024/2025





### Spændeelementer med specialtryksko TWM28

	Glidebøjle kpl. med knebelgreb og specialtryksko		Specialtryksko standard		Specialtryksko med riller		Specialtryksko med prisme	
	Udladning mm	til skinne mm	Spindelboring mm	Spænde-stift mm	Spindelboring mm	Spænde-stift mm	Spindelboring mm	Spænde-stift mm
<b>TWM28</b>	120	28 x 11	12	5 x 20	12	5 x 20	12	5 x 20
Bestill.-nr.	3101521		3100736		3101192		3101193	

### Spændeelementer TW28GRS / TWVAD / TWA-STC / TW28AV

	Skinne		Gribearms kpl.		Forlænger	
	Spændvidde mm	Skinne mm	Udladning mm	til skinne mm	Hul Ø mm	Korrektionsvanding mm
<b>TW28GRS</b>	300	28 x 11	120	28 x 11		
Bestill.-nr.	3101706		3101590		-	
<b>TWVAD TW16VAD TW16A-STC</b>					16	15-200
Bestill.-nr.	-		-		TW16X	
<b>TWVAD TW28VAD TW28A-STC TW28AV</b>					28	15-300
Bestill.-nr.	-		-		TW28X	

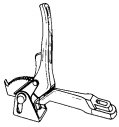
## Maskinbordspændere BAS, BS, SGHS

	Trykarm	Tryksko	Spindel	Glidebøjle kpl.		Udløser kpl.
		 4 stk.	 2 stk.			 2 stk.
				Udladning mm	til skinne mm	Bolt Ø x længde mm
<b>BAS...9-4</b>						
Bestill.-nr.	3101428	3101431	3101726	-		-
<b>BAS...10-6</b>						
Bestill.-nr.	3101429	3101431	3101726	-		-
<b>BSP...10-6</b>						
Bestill.-nr.	3101430	-	3101726	-		-
<b>BS2N / BS3N</b>						5h11 x 26
Bestill.-nr.	-	-	-	-		<b>3100747</b>
<b>BS4N</b>						5h11 x 26
Bestill.-nr.	-	-	-	-		<b>3100748</b>
<b>BS5N / BS6N SG-HS</b>				140	30 x 15	
Bestill.-nr.	-	-	-	<b>3101432</b>		-

## BESSEY Liste over tilbehør og reservedele 2024/2025

### Korpustvinger KR/KRV/KRE/KREV

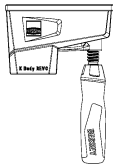
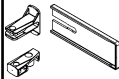
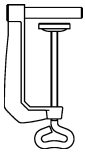
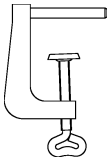
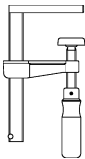
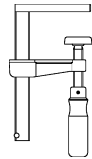
	Underdel kpl. med glidebøjle		Sæt i pose	Bordklemme		Bordklemme		Bordklemme		Bordklemme	
	Udladning mm	til skinne mm		Spændvidde mm	Udladning mm	Spændvidde mm	Udladning mm	Spændvidde mm	Udladning mm	Spændvidde mm	Udladning mm
											
			3 beskyttelsesklapper 2 mellemlæg 1 endesikring	Ø 8 mm		Ø 8 mm		Ø 8 mm		Ø 8 mm	
<b>KR...-2K</b> <b>KRV...-2K</b> <b>KRE...-2K</b> <b>KREV...-2K</b>	95	29 x 9		60	22	60	28	100	50	150	50
Bestill.-nr.	3101774		3101775	TK6		RB269		LM10/5R8		LM15/5R8	

### Korpustvinger K/KR/KRV/KRE/KREV

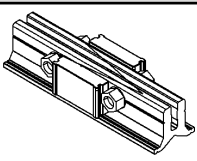
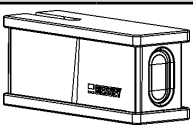
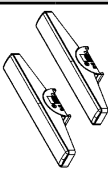
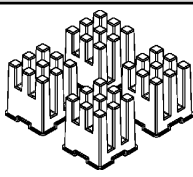
	Korpustvingeforlænger	Bevægelig overdel		Adapter, drejelig		Rammepressesæt
		Udladning mm	til skinne mm	Kæbehøjde mm	Kæbebredde mm	
						
				2 stk./pakke		4 stk./pakke
<b>K...</b>		95	29 x 9	-		
Bestill.-nr.	KBX20	KRE-VO				KP
<b>KR...-2K</b> <b>KRV...-2K</b> <b>KRE...-2K</b> <b>KREV...-2K</b>		95	29 x 9	170	25	
Bestill.-nr.	KBX20	KRE-VO		KR-AS		KP

## Korpusspænder KS

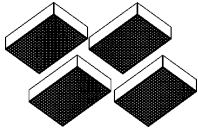
Trykstykke	
	
4 stk./pakke	
<b>KS</b>	
<b>Bestill.-nr.</b>	<b>3101845</b>

## Planspænder FK

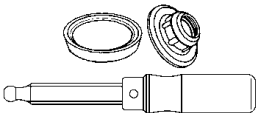
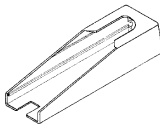
Skrue kpl. med trægreb		Beskyttelseskappe
		
		2 stk.
<b>Trapezformet gevind mm</b>		<b>Udladning mm</b>
<b>FK16-8</b>		80
<b>Bestill.-nr.</b>	-	<b>3101790</b>
<b>FK...-10</b>	16 x 4	100
<b>Bestill.-nr.</b>	<b>3101386</b>	<b>3101789</b>

## Geartvinge GearKlamp GK

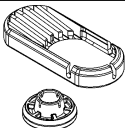

Tryksko + beskyttelseskappe in sæt	
	
5 par	
<b>Ø mm</b>	
<b>GK</b>	26
<b>Bestill.-nr.</b>	<b>3101840</b>

## BESSEY Liste over tilbehør og reservedele 2024/2025

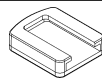
### Enhåndstvinger EHZ / EZS

	Beskyttelseskappesæt	Beskyttelseskappesæt
	 <p>5 par</p>	 <p>10 stk.</p>
	Ø mm	mm
<b>EHZ...-2K</b>	32	
Bestill.-nr.	3101402	-
<b>EZS</b>		40 x 48
Bestill.-nr.	-	3101841

### Enhåndstvinger EZ



	Beskyttelseskappesæt	Fastspændingsbeslag
	 <p>10 stk.</p>	 <p>2 stk.</p>
<b>EZM</b>		
Bestill.-nr.	3101959	3101962
<b>EZL</b>		
Bestill.-nr.	3101960	-
<b>EZXL</b>		
Bestill.-nr.	3101961	-

### Enhåndstvinger EZ360



	Beskyttelseskappesæt
	 <p>6 stk.</p>
<b>EZ360</b>	
Bestill.-nr.	3102055

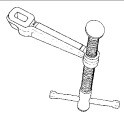
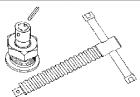
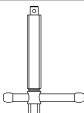
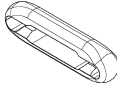

## Spærtvinger SPZ60K og SPZ80K

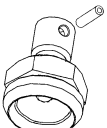

	Glidebøjle kpl.	Kombisæt (spindel + særlig trykplade + spændstift)		Skrue		Knebel tilbehør KA	Tryksko med beskyttelseskappe
		 uden sekskant		 med sekskant		 2 stk.	 4 stk.
	til skinne mm	Trapezfor- met gevind mm	Knebel Ø x længde mm	Trapezfor- met gevind mm	Knebel Ø x længde mm		
<b>SPZ60K</b>	27 x 13	18 x 5	10 x 120				
Bestill.-nr.	3101338	3100398		-		3101194*	3101188
<b>SPZ80K</b>	30 x 15	20 x 5	11 x 120	20 x 5	11 x 120		
Bestill.-nr.	3101330	3100399		3101815		-	-

## Spærtvinger SPZ80K

	Specialtryksko standard		Specialtryksko med riller		Specialtryksko med prisme		Skæring	
								
	Spindel- boring mm	Spænde- stift mm	Spindel- boring mm	Spænde- stift mm	Spindel- boring mm	Spænde- stift mm	Spindel- boring mm	Spænde- stift mm
<b>SPZ80K</b>	12	5 x 20	12	5 x 20	12	5 x 20	12	5 x 20
Bestill.-nr.	3100736		3101192		3101193		3101219*	

## BESSEY Liste over tilbehør og reservedele 2024/2025

### Griptænger GRZ

	Beskyttelseskapper til GRZ10 og GRZ20	Beskyttelseskapper til GRZRO
	 4 stk.	 2 par
<b>GRZ 10 - GRZ 20</b>		
Bestill.-nr.	3100576	-
<b>GRZRO</b>		
Bestill.-nr.	-	3101547

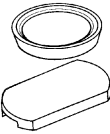

### Hightech-hurtigtvinger KliKlamp KLI

	Beskyttelseskapper til over- og underdel	
	 10 par	
	til Ø mm	til bredde (overdel) mm
<b>KLI</b>	25,5	23
Bestill.-nr.	3101393	

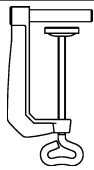
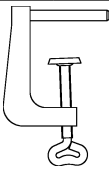
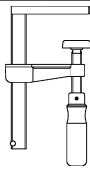
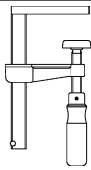
## Skruestik S10 / Vinkelspænder WS

	Bordklemme		Bordklemme		Bordklemme		Bordklemme	
	 Ø 8 mm		 Ø 8 mm		 Ø 8 mm		 Ø 8 mm	
	Spænd- vidde mm	Udladning mm	Spænd- vidde mm	Udladning mm	Spænd- vidde mm	Udladning mm	Spænd- vidde mm	Udladning mm
<b>S10-ST / WS 3</b>	60	22	60	28	100	50	150	50
<b>Bestill.-nr.</b>	<b>TK6</b>		<b>RB269</b>		<b>LM10/5R8</b>		<b>LM15/5R8</b>	

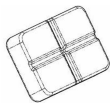
## Enhånd bordtvinger EZR

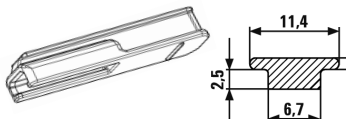
	Beskyttelseskappesæt	Fastspændingsbeslag	Adapter til styreskinner (Bosch/Mafell)
	 10 stk.	 2 stk.	 2 stk.
<b>EZR</b>			
<b>Bestill.-nr.</b>	<b>3101959</b>	<b>3101962</b>	<b>3102016</b>

## Helsmedet bordtvinger GTR

	Beskyttelseskapper til over- og underdel	
	 10 par	
	til Ø mm	til bredde (overdel) mm
<b>GTR</b>	22	17
<b>Bestill.-nr.</b>	<b>3101391</b>	

## BESSEY Liste over tilbehør og reservedele 2024/2025

### Båndspændere BAN

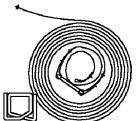
Bånd reservedel/forlænger	
	
<b>BAN 700 / SVH</b>	Bånd 7100 mm, 2 Spændeklodser
<b>Bestill.-nr.</b>	<b>3100832</b>

### Enhåndskantvinger EKT

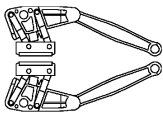
	Reservedel sæt	Bakker kpl. med stødstang
	 <p>3 stk. beskyttelseskapper og 6 stk. spændebakkerne</p>	 <p>2 par</p>
<b>EKT55</b>		
<b>Bestill.-nr.</b>	<b>3101403</b>	<b>3100998</b>

### Kantvinger KT

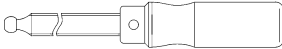
	Skrue kpl.
	
<b>KT5-1</b>	
<b>Bestill.-nr.</b>	<b>3101799</b>

## Kantvinger Kantenfix KF og pladestativ KFP

Spændebakkerne	
	
1 par inkl. fjeder	
<b>KF2</b>	
<b>Bestill.-nr.</b>	4102100
<b>KF4</b>	
<b>Bestill.-nr.</b>	4102056
<b>KFP</b>	
<b>Bestill.-nr.</b>	4102057*

\* egnet til KFP fra 2018 (røde trykbakker)

## Pladespænder PS

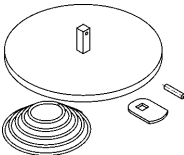
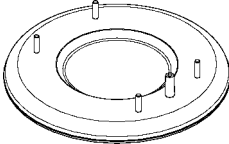
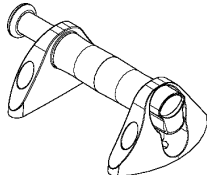

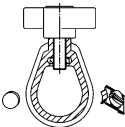

	Sugeskive	Gummiplade	Håndtag
			
	Ø mm	Ø mm	
<b>PS 55</b>	120		
<b>Bestill.-nr.</b>	3101839	-	-
<b>PS 130</b>		210	
<b>Bestill.-nr.</b>	-	3101685	3101686

## BESSEY Liste over tilbehør og reservedele 2024/2025

### Dørkarmsspænder TMS

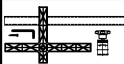
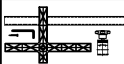
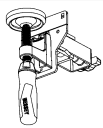
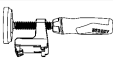
	<b>Spændestykke</b>
	
<b>TMS</b>	
Bestill.-nr.	3100983

### Dørkarmsspænder TU

	Trykplade med indvendigt rør og klemmestykke kpl.	Trykplade med yderrør og klemmestykke kpl.	Spændeæg, bred kpl. inkl. glide del	Udstyr kpl.	Forlænger	Filtstrimler	TU taske
						 4 stk.	
		Indre dimension mm					
<b>TU</b>		25 x 25					
Bestill.-nr.	3100934	3100935	3101752	3101764	TUX	3101632	3101762

### Dørkarmsrettetvinger TFM

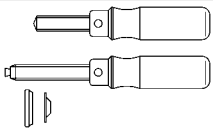
	<b>2 x spindel med løs trykplade og beskyttelsesklappe</b>
	
<b>TFM</b>	
Bestill.-nr.	3101408

## Rettevinger til vinduer FRK

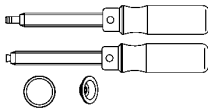
	2 x spindel med løs trykplade og beskyttelseskappe	
		
<b>FRK</b>		
Bestill.-nr.	3101409	

## Dørtvinger TB

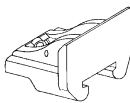
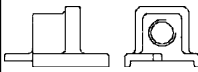
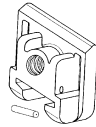
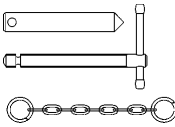
	Trykkæber	Spindelholder	Spændebakker	Spindelsæt TB
				
	Kæbe- bredde mm	Kæbe- højde mm	Trapezformet gevind mm	
<b>TB</b>	60 (80)	48	18 x 5	
Bestill.-nr.	3101793	3101792	3100920	3101405

## BESSEY Liste over tilbehør og reservedele 2024/2025

### Dørtvinger TL

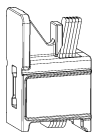

	<b>Trykkæber kpl.</b>
	
<b>TL</b>	
<b>Bestill.-nr.</b>	<b>3101877</b>

### Lofts- og teleskopstøtter STE, ST

	Multifunktions-/ laserholder	Støtteplade	Loftsstativ	Gulvstativ	Taske
					
<b>STE</b>					
<b>Bestill.-nr.</b>	<b>STE-LH</b>	<b>STE-SP35</b>	<b>STE-DS</b>	<b>STE-BS</b>	-
<b>ST</b>					
<b>Bestill.-nr.</b>	<b>STE-LH</b>	<b>STE-SP35</b>	<b>STE-DS</b>	<b>STE-BS</b>	-
<b>STE300 STE370</b>					
<b>Bestill.-nr.</b>	-	-	-	-	<b>STE-BAG</b>





## Lofts- og teleskopstøtter STE, ST

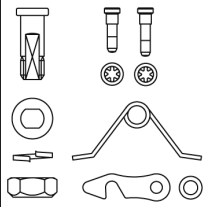
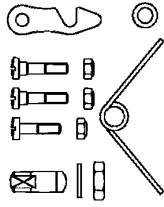
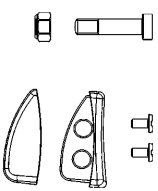

	Udskiftnings- kontaktflade	Låsepal ST	Sterngrebskrue
			 4 stk.
<b>STE</b>			
Bestill.-nr.	3101952	-	-
<b>ST</b>			
Bestill.-nr.	3101952	3101969	-
<b>STE-SP35</b>			
Bestill.-nr.	-	-	3101970

## BESSEY Liste over tilbehør og reservedele 2024/2025

### Håndpladesakse med udveksling

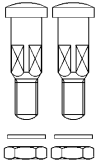
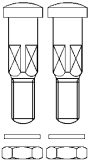
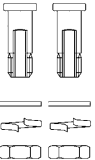

	Reservedel sæt 08/22A 27/29/123S	Reservedel sæt 17A-2	Nedholder kpl. 123S	Rullepose
				  til 3 sakse
<b>D08 ... D16A D22A D27AH-TIN/L</b>				
Bestill.-nr.	R032	-	-	7002464
<b>D16 / D16L / D16S</b>				
Bestill.-nr.	-	-	-	7002464
<b>D27 ... D29 ...</b>				
Bestill.-nr.	R001	-	-	7002464
<b>D17A-2/L</b>				
Bestill.-nr.	-	R043	-	7002464
<b>D123S</b>				
Bestill.-nr.	R001	-	R042	7002464

## Håndpladesakse i normal udførelse

	Skrueforbindelse kpl. M6 D8 x 24	Skrueforbindelse kpl. M6 D8 x 26	Skrueforbindelse kpl. M8 x1 x 22	Rullepose
	 <p>2 stk.</p>	 <p>2 stk.</p>	 <p>2 stk.</p>	 <p>til 3 sakse</p>
<b>D101-200 – D101-250</b> <b>D201-200 – D201-250</b> D102-225 D202-225 D107-225 – D107-275 D207-225 – D207-275 D114-250 – D114-275 D214-250 – D214-275 D159-200 – D159-250	<b>R034</b>	-	-	<b>7002464</b>
<b>D102-250 – D102-300</b> <b>D202-250 – D202-300</b> D106-250 D106A-250 D107-300 – D107-350 D207-300 – D207-350 D208-275 D209-275 D114-300 D214-300 D159-300 – D159-350	-	<b>R035</b>	-	<b>7002464</b>
<b>D116-260 – D116-280</b> <b>D216-260 – D216-280</b> D216-260-B-SBSK D216-280-B-SBSK D118-300 – D118-350 D218-300 – D218-350 D416-280 D 418-300 – D418-350	-	-	<b>R036</b>	<b>7002464</b>
<b>D407-275 – D407-300</b>	-	-	-	<b>7002464</b>



**Hobbyknive**

	Trapezklinger	Krogklinger	Krumme klinger
			
	10 stk.	10 stk.	5 stk.
DBKPH DBKWH DBKAH			
Bestill.-nr.	DBK-T	DBK-H	DBK-L

**BESSEY**  
Imagefilm



BESSEY Tool GmbH & Co. KG ■ Mühlwiesenstraße 40  
74321 Bietigheim-Bissingen, Germany  
Fon +49 7142 401-0 ■ Fax: +49 7142 401-452  
E-Mail: tool-info@bessey.de

Din forhandler:

liste-over-tilbehør-og-reservedele\_07/2024\_in  
Med forbehold for trykfejl.

Yderligere informationer  
findes på [www.bessey.de](http://www.bessey.de)

