

BESSEY Lijst van accessoires en reserveonderdelen 2024/2025

4-7 Lijmtangen met gegoten beugels



TG / TPN
TGK / TKPN
TGNT

8-11 Geheel stalen lijmtangen



GZ / GS
G...Z
GU25-12-6ZK
GMZ

12-13 Snelspanklemmen



GH / GSH
GHS / G...H

14-15 Constructieklemmen



SLM / SGM / SGL
SG...M / STBM
STBS / STBVC
SGU / STBU
GSL / GSM

16 Variable schroefklemmen



SLV / GSV

17 Constructieklemmen met achterspindel



GRA...12

17 Snelspanner



STC-VH / STC-HH
STC-HV / STC-HA
STC-IHH / STC-IHA
TW..A-STC
TW..VAD / TWVAD

18-20 Panelementen



TWV / TW
TWM28
TW28GRS
WNS-SET-MFT

21 Machinentafelspanners



BAS
BSN
SGHS

22 Corpuslijmtangen



KRE / KREV
KR / KRV / K

23 Corpusspanner



KS

23 Vlakspanner



FK

23 Aandrijfklem GearKlamp



GK

24 Eénhandsklemmen



EHZ / EZS / EZ

25 Spantenlijmtang



SPZ

26 Griptangen



GRZ
GRZRO

26 KliKlamp



KLI

27 Schroefspanner en hoekspanner



S10 / WS

27 Tafelklem



EZR / GTR

28 Bandspanner



BAN

29 Kantenlijmtangen en Platendrager



EKT
KT5-1
KF / KFP

29 Platenspanner



PS

**30-32 Deur- en venster-
montage-gereedschap**

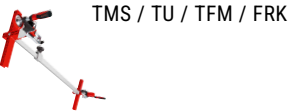

TMS / TU / TFM / FRK



TAN / TB / TL

**32-33 Plafond- en montage-
steun**



STE / ST

**34 Blikscharen met
hefboomoverbrenging**



**35 Standaard
blikscharen**



**36 Knabberscharen en
knipmessen**



Technische wijzigingen voorbehouden. Wij kunnen geen verantwoordelijkheid aanvaarden voor eventuele drukfouten.

De genoemde prijzen zijn vrijblijvende adviesverkoopprijzen exclusief BTW.

BESSEY Lijst van accessoires en reserveonderdelen 2024/2025

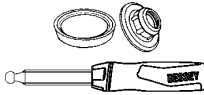
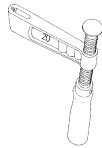
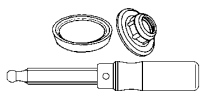

Lijmtangen met gegoten beugels

geschikt voor serie TG en TPN

	Ondergedeelte compleet met 2-componenten handgreep		2-componenten handgreep incl. verwisselbare drukplaat met beschermkap			Ondergedeelte compleet met houten handgreep		Houten handgreep incl. verwisselbare drukplaat met beschermkap		
	Span-diepte mm	voor profiel mm	Lengte x Ø mm	Kop Ø mm	Trapezi-umdraad mm	Span-diepte mm	voor profiel mm	Lengte x Ø mm	Kop Ø mm	Trapezi-umdraad mm
TG10 / TG...B5										
Bestelnr.	-		-			-		-		
Prijs	-		-			-		-		
TG12 / TG...B6										
Bestelnr.	-		-			-		-		
Prijs	-		-			-		-		
TG 16 TG...B8 TPN 16 TPN...B8			110 x 30	10	14 x 4					
Bestelnr.	-		3101179			-		-		
Prijs	-		12,28 EUR			-		-		
TG 20 TG...S10 TPN 20 TPN...S10			110 x 30	12	16 x 4	100	27 x 7	112 x 30	12	16 x 4
Bestelnr.	-		3101182			3101413		3101386		
Prijs	-		16,07 EUR			28,13 EUR		13,50 EUR		
TG 25 TG...S12 TPN 25 TPN...S12	120	29 x 9	130 x 34	12	16 x 4	120	29 x 9	125 x 32	12	16 x 4
Bestelnr.	3101832		3101186			3101414		3101389		
Prijs	39,17 EUR		17,86 EUR			37,28 EUR		15,51 EUR		
TG 30 TG...S14 TPN 30 TPN...S14	140	32 x 10	130 x 34	13	18 x 5	140	32 x 10	140 x 35	13	18 x 5
Bestelnr.	3101833		3101187			3101415		3101390		
Prijs	43,75 EUR		19,64 EUR			41,30 EUR		17,19 EUR		
TG 40 TG...S17	175	32 x 10	130 x 34	13	18 x 5	175	32 x 10	140 x 35	13	18 x 5
Bestelnr.	3101834		3101187			3101416		3101390		
Prijs	52,68 EUR		19,64 EUR			50,23 EUR		17,19 EUR		
TPN 40 TPN...S17	175	32 x 10	130 x 34	13	18 x 5	175	32 x 10	140 x 35	13	18 x 5
Bestelnr.	3101834		3101187			3101416		3101390		
Prijs	52,68 EUR		19,64 EUR			50,23 EUR		17,19 EUR		

Lijmtangen met gegoten beugels

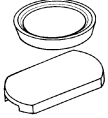
geschikt voor serie TG en TPN

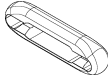
	Drukplaat met beschermkap uitwisselbaar van grootte 16	Beschermkap voor bovenste en onderste deel		Beschermkapstrook SKS	Knevelopzetstuk KA
					
	4 paar	10 paar		2 stuks	2 stuks
	Ø mm	voor Ø mm	voor breedte onderste deel mm		enkel voor knevelvarianten passend
TG10 / TG...B5	22	22	17		
Bestelnr.	3101339	3101391		-	-
Prijs	6,81 EUR	13,62 EUR			
TG12 / TG...B6	22	22	19		
Bestelnr.	3101339	3101392		-	-
Prijs	6,81 EUR	14,73 EUR			
TG 16 TG...B8 TPN 16 TPN...B8	25,5	25,5	23		
Bestelnr.	3101180	3101393		-	-
Prijs	10,27 EUR	15,51 EUR			
TG 20 TG...S10 TPN 20 TPN...S10	32	32	28		
Bestelnr.	3101183	3101394		-	3101194*
Prijs	11,72 EUR	16,07 EUR			15,63 EUR
TG 25 TG...S12 TPN 25 TPN...S12	32	32	30		
Bestelnr.	3101183	3101395		-	3101194*
Prijs	11,72 EUR	16,97 EUR			15,63 EUR
TG 30 TG...S14 TPN 30 TPN...S14	38,5	38,5	32		
Bestelnr.	3101188	3101396		-	3101194*
Prijs	13,50 EUR	17,86 EUR			15,63 EUR
TG 40 TG...S17	38,5	38,5	32		
Bestelnr.	3101188	3101396		-	3101194*
Prijs	13,50 EUR	17,86 EUR			15,63 EUR
TPN 40 TPN...S17	38,5				
Bestelnr.	3101188	-		SKS20/40	3101194*
Prijs	13,50 EUR			9,04 EUR	15,63 EUR

*Levering zolang de voorraad strekt

BESSEY Lijst van accessoires en reserveonderdelen 2024/2025

Lijmtangen met gegoten beugels

geschikt voor serie TGK en TKPN

	Ondergedeelte compleet met 2-componenten handgreep		2-componenten handgreep incl. verwisselbare drukplaat met beschermkap			Ondergedeelte compleet met houten handgreep		Handgreep incl. verwisselbare drukplaat met beschermkap		
	Span-diepte mm	voor profiel mm	Lengte x Ø mm	Kop Ø mm	Trapezi-umdraad mm	Span-diepte mm	voor profiel mm	Lengte x Ø mm	Kop Ø mm	Trapezi-umdraad mm
TGK TKPN	120	35 x 11	130 x 34	13	18 x 5	120	35 x 11	140 x 35	13	18 x 5
Bestelnr.	3101838		3101187			3101417		3101390		
Prijs	42,52 EUR		19,64 EUR			40,29 EUR		17,19 EUR		



Lijmtangen met gegoten beugels

geschikt voor serie TGK en TKPN

	Knevelgreep		Drukplaat met beschermkap	Beschermkapstrook SKS		Knevelopzetstuk KA
	Span-diepte mm	voor profiel mm	Ø mm	voor Ø mm	voor breedte onderste deel mm	enkel voor knevelvarianten passend
TGK TKPN			38,5	25,5	23	
Bestelnr.	-		3101188	SKS20/40		3101194*
Prijs			13,50 EUR	9,04 EUR		15,63 EUR
TGK-K	120	35 x 11	38,5	25,5	23	
Bestelnr.	3101418		3101188	SKS20/40		3101194*
Prijs	46,32 EUR		13,50 EUR	9,04 EUR		15,63 EUR

Lijmtangen met gegoten beugels

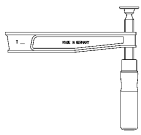
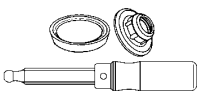
geschikt voor serie TGN

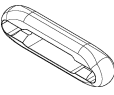
	Ondergedeelte compleet met handgreep		Houten handgreep incl. verwisselbare drukplaat met beschermkap			Drukplaat met beschermkap	Knevel-opzetstuk KA
							
	Spandiepte mm	voor profiel mm	Lengte x Ø mm	Kop Ø mm	Trapezium-draad mm	Ø mm	enkel voor knevelvarianten passend
TGN...T20	200	35 x 11	140 x 35	13	18 x 5	38,5	
Bestelnr.	3101419		3101390			3101188	3101194*
Prijs	67,85 EUR		17,19 EUR			13,50 EUR	15,63 EUR
TGN...T25	250	40 x 11	140 x 35	13	18 x 5	38,5	
Bestelnr.	3101420		3101390			3101188	3101194*
Prijs	78,58 EUR		17,19 EUR			13,50 EUR	15,63 EUR
TGN...T30	300	45 x 12	140 x 35	13	18 x 5	38,5	
Bestelnr.	3101421		3101390			3101188	3101194*
Prijs	98,10 EUR		17,19 EUR			13,50 EUR	15,63 EUR
TGN...T40			140 x 35	13	18 x 5	38,5	
Bestelnr.	-		3101390			3101188	3101194*
Prijs			17,19 EUR			13,50 EUR	15,63 EUR
TGN...T50			140 x 35	13	18 x 5	38,5	
Bestelnr.	-		3101390			3101188	3101194*
Prijs			17,19 EUR			13,50 EUR	15,63 EUR

*Levering zolang de voorraad strekt

BESSEY Lijst van accessoires en reserveonderdelen 2024/2025



Geheel stalen lijmtangen – nieuwe versie vanaf 01.07.09

geschikt voor serie GZ

	Glijbeugel compleet 2-componenten handgreep		2-componenten handgreep incl. verwisselbare drukplaat met beschermkap			Glijbeugel compleet met houten handgreep		Houten handgreep incl. verwisselbare drukplaat met beschermkap		
	Span- diepte mm	voor profiel mm	Lengte x Ø mm	Kop Ø mm	Trapezi- umdraad mm	Span- diepte mm	voor profiel mm	Lengte x Ø mm	Kop Ø mm	Trapezi- umdraad mm
GZ 10 / GZ 12										
Bestelnr. Prijs	-		-			-		-		
GZ 16			110 x 30	10	14 x 4					
Bestelnr. Prijs	-		3101179 12,28 EUR			-		-		
GZ 20 GZ...-10	100	22 x 8,5	110 x 30	12	16 x 4	100	22 x 8,5	112 x 30	12	16 x 4
Bestelnr. Prijs	3101955 23,66 EUR		3101182 16,07 EUR			3101516 24,33 EUR		3101386 13,50 EUR		
GZ 25 GZ...-12	120	24 x 9,5	130 x 34	12	16 x 4	120	24 x 9,5	125 x 32	12	16 x 4
Bestelnr. Prijs	3101835 30,35 EUR		3101186 17,86 EUR			3101517 28,24 EUR		3101389 15,51 EUR		
GZ 30	140	28 x 11	130 x 34	13	18 x 5	140	28 x 11	140 x 35	13	18 x 5
Bestelnr. Prijs	3101836 36,16 EUR		3101187 19,64 EUR			3101518 33,82 EUR		3101390 17,19 EUR		
GZ 40 - GZ 125	120	28 x 11	130 x 34	13	18 x 5	120	28 x 11	140 x 35	13	18 x 5
Bestelnr. Prijs	3101837 39,17 EUR		3101187 19,64 EUR			3101519 37,05 EUR		3101390 17,19 EUR		

Geheel stalen lijmtangen – nieuwe versie vanaf 01.07.09

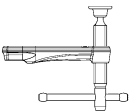
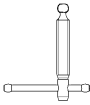
geschikt voor serie GZ

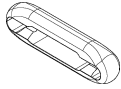
Glijbeugel compleet met knevelgreep		Knevelgreep	Opklapbare 2-componenten handgreep incl. verwisselbare drukplaat met beschermkap			Drukplaat met beschermkap uitwisselbaar van grootte 16	Knevelopzetstuk KA	
								
Span- diepte mm	voor profiel mm	Trapeziumdraad mm	Lengte x Ø mm	Kop Ø mm	Trapezi- umdraad mm	Ø mm	enkel voor knevelvarianten passend	
GZ 10 / GZ 12						22		
Bestelnr.	-	-		-		3101339	-	
Prijs						6,81 EUR		
GZ 16		14 x 4				25,5		
Bestelnr.	-	3101795		-		3101180	-	
Prijs		14,96 EUR				10,27 EUR		
GZ 20 GZ...-10	100	22 x 8,5	16 x 4			32		
Bestelnr.	3101441	3101796		-		3101183	3101194*	
Prijs	31,81 EUR	16,07 EUR				11,72 EUR	15,63 EUR	
GZ 25 GZ...-12	120	24 x 9,5	16 x 4	125 x 35	12	16 x 4	32	
Bestelnr.	3101444	3101796		3101958		3101183	3101194*	
Prijs	34,27 EUR	16,07 EUR		21,77 EUR		11,72 EUR	15,63 EUR	
GZ 30	140	28 x 11	18 x 5			38,5		
Bestelnr.	3101447	3101797		-		3101188	3101194*	
Prijs	39,84 EUR	17,97 EUR				13,50 EUR	15,63 EUR	
GZ 40 - GZ 125	120	28 x 11	18 x 5			38,5		
Bestelnr.	3101450	3101797		-		3101188	3101194*	
Prijs	43,08 EUR	17,97 EUR				13,50 EUR	15,63 EUR	

*Levering zolang de voorraad strekt

BESSEY Lijst van accessoires en reserveonderdelen 2024/2025



OMEGA-Geheel stalen lijmtangen en Geheel stalen lijmtangen classiX alsmede Geheel stalen lijmtangen – oude versie tot 30.06.09

geschikt voor serie GMZ, G...Z, GS

	Glijbeugel compleet met houten handgreep		Glijbeugel compleet met knevelgreep		Houten handgreep incl. verwisselbare drukplaat met beschermkap			2-componenten handgreep incl. verwisselbare drukplaat met beschermkap		
	Span-diepte mm	voor profiel mm	Span-diepte mm	voor profiel mm	Lengte x Ø mm	Kop Ø mm	Trapezi-umdraad mm	Lengte x Ø mm	Kop Ø mm	Trapezi-umdraad mm
G10Z / G12Z GS10 / GS12										
Bestelnr.	-		-		-			-		
Prijs	-		-		-			-		
G16Z / GS16								110 x 30	10	14 x 4
Bestelnr.	-		-		-			3101179		
Prijs	-		-		-			12,28 EUR		
G20Z/G...-S10Z GS20 GM 20Z GM...S10Z	100	19,5 x 9,5	100	19,5 x 9,5	112 x 30	12	16 x 4	110 x 30	12	16 x 4
Bestelnr.	3101422		3101800		3101386			3101182		
Prijs	24,33 EUR		31,92 EUR		13,50 EUR			16,07 EUR		
G25Z/G...-S12Z GS25 GM 25Z GM...-S12Z GU25-12-6ZK	120	22 x 10,5	120	22 x 10,5	125 x 32	12	16 x 4	130 x 34	12	16 x 4
Bestelnr.	3101423		3101801		3101389			3101186		
Prijs	28,24 EUR		34,27 EUR		15,51 EUR			17,86 EUR		
G30Z / GS30 GM30Z	140	25 x 12	140	25 x 12	140 x 35	13	18 x 5	130 x 34	13	18 x 5
Bestelnr.	3101424		3101802		3101390			3101187		
Prijs	33,82 EUR		38,95 EUR		17,19 EUR			19,64 EUR		
G40Z-G60Z GS40-GS60 GM40Z-GM60Z	120	25 x 12	120	25 x 12	140 x 35	13	18 x 5	130 x 34	13	18 x 5
Bestelnr.	3101425		3101803		3101390			3101187		
Prijs	37,05 EUR		43,08 EUR		17,19 EUR			19,64 EUR		
G80Z-G125Z GS80-GS100 GM80Z-GM125Z	120	27 x 13	120	27 x 13	140 x 35	13	18 x 5	130 x 34	13	18 x 5
Bestelnr.	3101426		3101804		3101390			3101187		
Prijs	37,05 EUR		43,08 EUR		17,19 EUR			19,64 EUR		

OMEGA-Lijmtangen en Geheel stalen lijmtangen classiX alsmede Geheel stalen lijmtangen – oude versie tot 30.06.09

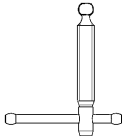
geschikt voor serie GMZ, G...Z, GS

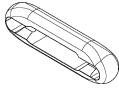
	Knevelgreep	Drukplaat met beschermkap uitwisselbaar van grootte 16	Knevelopzetstuk KA
			
		4 paar	2 stuks
	Trapeziumdraad mm	Ø mm	enkel voor knevelvarianten passend
G10Z / G12Z GS10 / GS12		22	
Bestelnr.	-	3101339	-
Prijs		6,81 EUR	
G16Z / GS16	14 x 4	25,5	
Bestelnr.	3101795	3101180	-
Prijs	14,96 EUR	10,27 EUR	
G20Z/G...S10Z GS20 GM 20Z GM...S10Z	16 x 4	32	
Bestelnr.	3101796	3101183	3101194*
Prijs	16,07 EUR	11,72 EUR	15,63 EUR
G25Z/G...S12Z GS25 GM 25Z GM...S12Z GU25-12-6ZK	16 x 4	32	
Bestelnr.	3101796	3101183	3101194*
Prijs	16,07 EUR	11,72 EUR	15,63 EUR
G30Z / GS30 GM30Z	18 x 5	38,5	
Bestelnr.	3101797	3101188	3101194*
Prijs	17,97 EUR	13,50 EUR	15,63 EUR
G40Z-G60Z GS40-GS60 GM40Z-GM60Z	18 x 5	38,5	
Bestelnr.	3101797	3101188	3101194*
Prijs	17,97 EUR	13,50 EUR	15,63 EUR
G80Z-G125Z GS80-GS100 GM80Z-GM125Z	18 x 5	38,5	
Bestelnr.	3101797	3101188	3101194*
Prijs	17,97 EUR	13,50 EUR	15,63 EUR

*Levering zolang de voorraad strekt

BESSEY Lijst van accessoires en reserveonderdelen 2024/2025

Snelspanklemmen – GH – nieuwe versie vanaf 01.03.10

geschikt voor serie GH

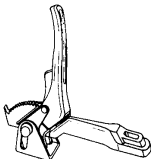
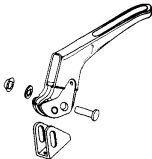
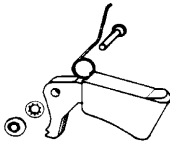
	Glijbeugel compleet		Hefboom met drukplaat compleet	Vergrendelpal compleet
				
				2 stuks
	Spandiepte mm	voor profiel mm	Bout-Ø x l mm	Bout-Ø x l mm
GH 12 GH 16				5h11 x 21
Bestelnr.	-			3101399
Prijs				11,72 EUR
GH 20 GH...-10	100	22 x 8,5	10 x 33,5	5h11 x 23
Bestelnr.	3101522		3101397	3101400
Prijs	64,74 EUR		25,22 EUR	12,50 EUR
GH 25 GH...-12	120	24,5 x 9,5	10 x 33,5	5h11 x 23
Bestelnr.	3101523		3101397	3101400
Prijs	66,75 EUR		25,22 EUR	12,50 EUR
GH 30	140	28 x 11	12 x 38	5h11 x 26
Bestelnr.	3101524		3101398	3101401
Prijs	81,59 EUR		35,49 EUR	13,62 EUR
GH 40 - GH 100	120	28 x 11	12 x 38	5h11 x 26
Bestelnr.	3101525		3101398	3101401
Prijs	92,52 EUR		35,49 EUR	13,62 EUR

Snelspanklemmen classiX – GSH

alsmede snelspanklemmen – GH – oude versie tot 28.02.10

geschikt voor serie G...H, GSH

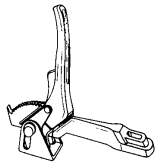
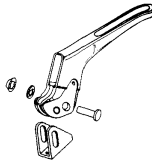
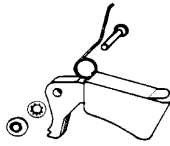

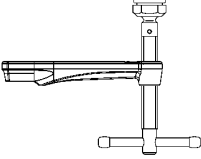
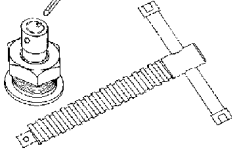
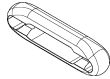

	Glijbeugel compleet		Hefboom met drukplaat compleet	Vergrendelpal compleet
				
				2 stuks
	Spandiepte mm	voor profiel mm	Bout-Ø x l mm	Bout-Ø x l mm
G12H / G...S6H G16H / G...S8H GSH12 - GSH16				5h11 x 21
Bestelnr.	-		-	3101399
Prijs				11,72 EUR
G20H / G...S10H GSH20	100	19,5 x 9,5	10 x 33,5	5h11 x 23
Bestelnr.	3101333		3101397	3101400
Prijs	64,74 EUR		25,22 EUR	12,50 EUR
G25H / G...S12H GSH25 GU-H	120	22 x 10,5	10 x 33,5	5h11 x 23
Bestelnr.	3101334		3101397	3101400
Prijs	66,75 EUR		25,22 EUR	12,50 EUR
G30H GSH30	140	25 x 12	12 x 38	5h11 x 26
Bestelnr.	3101335		3101398	3101401
Prijs	81,59 EUR		35,49 EUR	13,62 EUR
G40H - G60H GSH40 - GSH60	120	25 x 12	12 x 38	5h11 x 26
Bestelnr.	3101336		3101398	3101401
Prijs	92,52 EUR		35,49 EUR	13,62 EUR
G80H - G100H	120	27 x 13	12 x 38	5h11 x 26
Bestelnr.	3101337		3101398	3101401
Prijs	98,44 EUR		35,49 EUR	13,62 EUR

BESSEY Lijst van accessoires en reserveonderdelen 2024/2025

Hoogwaardige constructieklemmen – SLM en SGM – **nieuwe versie vanaf 01.07.08**

	Glijbeugel compleet		Combiset (Spindel + speciale drukplaat + veerpin)		Knevelopzetstuk KA
					
	Spandiepte mm	voor profiel mm	Trapeziumdraad mm	Knevel Ø x Lengte mm	2 stuks
SL...M	120	28 x 11	18 x 5	10 x 120	
Bestelnr. Prijs	3101521 62,16 EUR		3100398 48,77 EUR		3101194* 15,63 EUR
SG...M	140	34 x 13	20 x 5	11 x 120	
Bestelnr. Prijs	3101407 78,80 EUR		3100399 53,58 EUR		-

Hoogwaardige constructieklemmen – SLM/SGM/STBM/STBVC/SGU/STBU/STBS

	Speciale drukplaat standaard		Speciale drukplaat gekarteld		Speciale drukplaat met prisma		Schroef- draadbus met borgring	Wig STBS
								
	Spindelgat mm	Veerpen mm	Spindelgat mm	Veerpen mm	Spindelgat mm	Veerpen mm	Schroef- draad	2 stuks
SLM / SGM STBM / STBVC SGU	12	5 x 20	12	5 x 20	12	5 x 20		
Bestelnr. Prijs	3100736 24,78 EUR		3101192 27,79 EUR		3101193 27,79 EUR		-	-
STBU	12	5 x 20	12	5 x 20	12	5 x 20		
Bestelnr. Prijs	3100737 37,28 EUR		3101192 27,79 EUR		3101193 27,79 EUR		-	-
STBS	12	5 x 20					M 24	
Bestelnr. Prijs	3100737 37,28 EUR		-		-		3100579 19,53 EUR	3101788 15,96 EUR

Hoogwaardige constructieklemmen – STBVC/STB/STBS

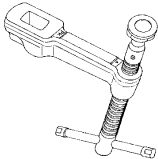
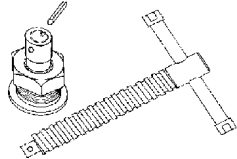
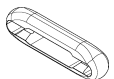

Hoogwaardige constructieklemmen classIX – GSL en GSM

alsmede Hoogwaardige constructieklemmen – SGL en SGM – **oude versie tot 30.06.08**



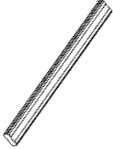
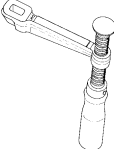
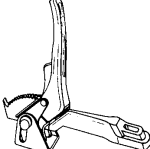
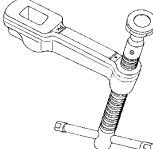

	Glijbeugel compleet		Combiset (Spindel + speciale drukplaat + veerpin)		Knevelopzetstuk KA
					
	Spandiepte mm	voor profiel mm	Trapeziumdraad mm	Knevel Ø x Lengte mm	2 stuks
SGL...M / GSL	120	27 x 13	18 x 5	10 x 120	
Bestelnr.	3101338		3100398		3101194*
Prijs	62,16 EUR		48,77 EUR		15,63 EUR
SG...M	120	30 x 15	20 x 5	11 x 120	
Bestelnr.	3101329		3100399		-
Prijs	72,77 EUR		53,58 EUR		
SG30M / GSM / SGU	140	30 x 15	20 x 5	11 x 120	
Bestelnr.	3101330		3100399		-
Prijs	78,80 EUR		53,58 EUR		
SG..T20M	200	30 x 15	20 x 5	11 x 120	
Bestelnr.	3101331		3100399		-
Prijs	100,56 EUR		53,58 EUR		
STB...M/STBU	175	40 x 20	22 x 5	11 x 180	
Bestelnr.	3101332		3100400		-
Prijs	103,34 EUR		60,49 EUR		
STBS	200	50 x 25	M24	18 x 345	
Bestelnr.	3101798		3100401		-
Prijs	296,66 EUR		152,90 EUR		
STBVC	100	40 x 20	22 x 5	11 x 180	
Bestelnr.	3101882		3100400		-
Prijs	81,69 EUR		60,49 EUR		

BESSEY Lijst van accessoires en reserveonderdelen 2024/2025

Variabele hoogwaardige constructieklemmen SLV, GSV

	Profiel met 2 eindbeveiliging		Glijbeugel compleet met houten handgreep		Glijbeugel compleet met hefboomgreep		Glijbeugel compleet met knevelgreep		Knevel-opzetstuk KA
									 2 stuks
	Spandiepte mm	Profiel mm	Spandiepte mm	voor profiel mm	Spandiepte mm	voor profiel mm	Spandiepte mm	voor profiel mm	enkel voor knevelvarianten passend
SLV	1000	27 x 13	120	27 x 13	120	27 x 13	120	27 x 13	
Bestelnr.	3101731		3101426		3101337		3101338		3101194*
Prijs	57,70 EUR		37,05 EUR		98,44 EUR		62,16 EUR		15,63 EUR
SLV	1500	27 x 13	120	27 x 13	120	27 x 13	120	27 x 13	
Bestelnr.	3101732		3101426		3101337		3101338		3101194*
Prijs	117,63 EUR		37,05 EUR		98,44 EUR		62,16 EUR		15,63 EUR
SLV	2000	27 x 13	120	27 x 13	120	27 x 13	120	27 x 13	
Bestelnr.	3101733		3101426		3101337		3101338		3101194*
Prijs	176,45 EUR		37,05 EUR		98,44 EUR		62,16 EUR		15,63 EUR



GSV	3000	30 x 15	-	-	-	-	120	30 x 15	-
Bestelnr.	3101612		-		-		3101329		-
Prijs	264,85 EUR		-		-		72,77 EUR		-
GSV	3000	30 x 15	-	-	-	-	140	30 x 15	-
Bestelnr.	3101612		-		-		3101330		-
Prijs	264,85 EUR		-		-		78,80 EUR		-
GSV	3000	30 x 15	-	-	-	-	200	30 x 15	-
Bestelnr.	3101612		-		-		3101331		-
Prijs	264,85 EUR		-		-		100,56 EUR		-

	Speciale drukplaat standaard		Speciale drukplaat gekarteld		Speciale drukplaat met prisma		Eind-beveiliging
							 2 paar
	Spindelgat mm	Veerpen mm	Spindelgat mm	Veerpen mm	Spindelgat mm	Veerpen mm	
SLV / GSV	12	5 x 20	12	5 x 20	12	5 x 20	
Bestelnr.	3100736		3101192		3101193		3101782
Prijs	24,78 EUR		27,79 EUR		27,79 EUR		16,63 EUR

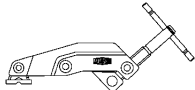
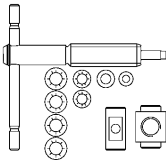
Constructieklemmen met achterspindel – nieuwe versie vanaf 01.04.12

	Grijparm compleet		Spindel compleet	
				
	Spandiepte mm	voor profiel mm	Trapeziumdraad mm	Knevel Ø x l mm
GRA...12	120	28 x 11	18 x 5	8 x 110
Bestelnr.	3101590		3100562	
Prijs	107,71 EUR		18,97 EUR	

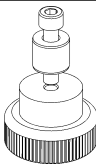
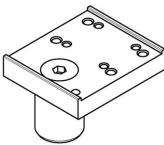
Variabele snelspanner STC

	Spindelset compleet	Voor multifunctionele tafel Adapter	Voor lastafels			
			Snelspanner-adapter		Verlengstuk	
		 1 cilinderbout DIN 912 M 8 x 35 1 steekbout D20 x 17 1 kartelmoer M8				
			Gat Ø	Gat Ø	Gat Ø	Aanpas- singsbereik
STC-VH20 / STC-HH20 STC-IHH 15			16	28		
Bestelnr.	3101627	-	TW16A-STC	TW28A-STC	-	
Prijs	4,80 EUR		26,89 EUR	28,13 EUR		
STC-HV20 / STC-HA20 STC-IHA 15						
Bestelnr.	3101627	-	-	-	-	
Prijs	4,80 EUR					
STC-VH50 / STC-HH 50 STC-IHH 25			16	28		
Bestelnr.	3101589	STC-SET-T20	TW16A-STC	TW28A-STC	-	
Prijs	5,24 EUR	12,95 EUR	26,89 EUR	28,13 EUR		
STC-HH 70			16	28		
Bestelnr.	3101588	STC-SET-T20	TW16A-STC	TW28A-STC	-	
Prijs	5,47 EUR	12,95 EUR	26,89 EUR	28,13 EUR		
TW16A-STC TW16VAD / TWVAD					16	15-200
Bestelnr.	-	-	-	-	TW16X	
Prijs					21,99 EUR	
TW28A-STC TW28VAD / TWVAD					28	15-300
Bestelnr.	-	-	-	-	TW28X	
Prijs					35,50 EUR	

BESSEY Lijst van accessoires en reserveonderdelen 2024/2025

Spanelement met variabele spandiepte TWV

	Profiel		Kruishouder compleet	Glijbeugel compleet met 2-componenten handgreep		Glijbeugel compleet met knevelgreep		Glijbeugel compleet met hefboomgreep		Werkbank-adapter
	Span-diepte mm	Profiel mm	voor profiel mm	Span-diepte mm	voor profiel mm	Span-diepte mm	voor profiel mm	Span-diepte mm	voor profiel mm	geschikt voor
TWV16	200	22 x 8,5	22 x 8,5	30-150	22 x 8,5	30-150	22 x 8,5	60-150	22 x 8,5	19 mm/3/4"
Bestelnr.	3101740		3101744	3101741		3101742		3101743		TW16AW19
Prijs	37,72 EUR		33,26 EUR	35,38 EUR		33,03 EUR		48,44 EUR		14,84 EUR
TWV16	200	22 x 8,5	22 x 8,5	30-150	22 x 8,5	30-150	22 x 8,5	60-150	22 x 8,5	20 mm/13/16"
Bestelnr.	3101740		3101744	3101741		3101742		3101743		TW16AW20
Prijs	37,72 EUR		33,26 EUR	35,38 EUR		33,03 EUR		48,44 EUR		16,18 EUR
TWV16	200	22 x 8,5	22 x 8,5	30-150	22 x 8,5	30-150	22 x 8,5	60-150	22 x 8,5	-
Bestelnr.	3101740		3101744	3101741		3101742		3101743		-
Prijs	37,72 EUR		33,26 EUR	35,38 EUR		33,03 EUR		48,44 EUR		
TWV16	200	22 x 8,5	22 x 8,5	30-150	22 x 8,5	30-150	22 x 8,5	60-150	22 x 8,5	30 mm/1 3/16"
Bestelnr.	3101740		3101744	3101741		3101742		3101743		TW16AW30
Prijs	37,72 EUR		33,26 EUR	35,38 EUR		33,03 EUR		48,44 EUR		19,19 EUR
TWV28	300	28 x 11	28 x 11	40-175	28 x 11	40-175	28 x 11	110-175	28 x 11	-
Bestelnr.	3101706		3101710	3101707		3101708		3101709		-
Prijs	44,53 EUR		38,95 EUR	41,63 EUR		38,62 EUR		57,03 EUR		

Horizontale spanner voor multifunctionele tafel WNS-SET-MFT



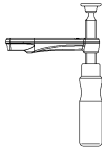
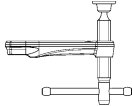
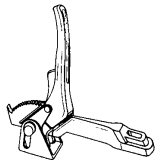
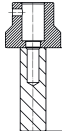

Bankhaken voor multifunctionele tafel	
 <p>4 x bankhaken 4 x kartelmoer</p>	
Bout-Ø mm	
WNS-SET-MFT	20
Bestelnr.	BH-MFT
Prijs	14,39 EUR

Spanelement met een vaste spandiepte TW

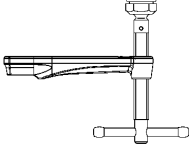

	Profiel		Glijbeugel compleet met houten handgreep		Glijbeugel compleet met knevelgreep		Glijbeugel compleet met hefboomgreep		Werkbank-adapter
									
	Spandiepte mm	Profiel mm	Spandiepte mm	voor profiel mm	Spandiepte mm	voor profiel mm	Spandiepte mm	voor profiel mm	geschikt voor
TW16	200	22 x 8,5	100	22 x 8,5	100	22 x 8,5	100	22 x 8,5	19 mm/3/4"
Bestelnr.	3101740		3101516		3101441		3101522		TW16AW19
Prijs	37,72 EUR		24,33 EUR		31,81 EUR		64,74 EUR		14,84 EUR
TW16	200	22 x 8,5	100	22 x 8,5	100	22 x 8,5	100	22 x 8,5	20 mm/13/16"
Bestelnr.	3101740		3101516		3101441		3101522		TW16AW20
Prijs	37,72 EUR		24,33 EUR		31,81 EUR		64,74 EUR		16,18 EUR
TW16	200	22 x 8,5	100	22 x 8,5	100	22 x 8,5	100	22 x 8,5	-
Bestelnr.	3101740		3101516		3101441		3101522		-
Prijs	37,72 EUR		24,33 EUR		31,81 EUR		64,74 EUR		-
TW16	200	22 x 8,5	100	22 x 8,5	100	22 x 8,5	100	22 x 8,5	30 mm/1 3/16"
Bestelnr.	3101740		3101516		3101441		3101522		TW16AW30
Prijs	37,72 EUR		24,33 EUR		31,81 EUR		64,74 EUR		19,19 EUR
TW28	300	28 x 11	120	28 x 11	120	28 x 11	120	28 x 11	-
Bestelnr.	3101706		3101519		3101450		3101525		-
Prijs	44,53 EUR		37,05 EUR		43,08 EUR		92,52 EUR		-
TW28	300	28 x 11	140	28 x 11	140	28 x 11	140	28 x 11	-
Bestelnr.	3101706		3101518		3101447		3101524		-
Prijs	44,53 EUR		33,82 EUR		39,84 EUR		81,59 EUR		-

BESSEY Lijst van accessoires en reserveonderdelen 2024/2025



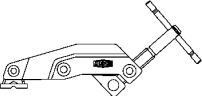

Spanelement met speciale drukplaat TWM28

	Glijbeugel compleet met knevelgreep en speciale drukplaat		Speciale drukplaat standaard		Speciale drukplaat gekarteld		Speciale drukplaat met prisma	
								
	Spandiepte mm	voor profiel mm	Spindelgat mm	Veerpen mm	Spindelgat mm	Veerpen mm	Spindelgat mm	Veerpen mm
TWM28	120	28 x 11	12	5 x 20	12	5 x 20	12	5 x 20
Bestelnr.	3101521		3100736		3101192		3101193	
Prijs	62,16 EUR		24,78 EUR		27,79 EUR		27,79 EUR	

Spanelement TW28GRS / TWVAD / TWA-STC / TW28AV

	Profiel		Grijparm compleet		Verlenging	
						
	Spanwijdte mm	Profiel mm	Spandiepte mm	voor profiel mm	Gat Ø mm	Aanpassingsbereik mm
TW28GRS	300	28 x 11	120	28 x 11		
Bestelnr.	3101706		3101590		-	
Prijs	44,53 EUR		107,71 EUR			
TWVAD TW16VAD TW16A-STC					16	15-200
Bestelnr.	-		-		TW16X	
Prijs					21,99 EUR	
TWVAD TW28VAD TW28A-STC TW28AV					28	15-300
Bestelnr.	-		-		TW28X	
Prijs					35,50 EUR	

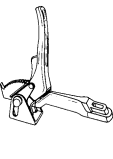
Machinetafelspanner BAS, BS, SGHS

	Drukarm	Drukschoen	Spindel	Glijbeugel compleet		Ver-grendelpal compleet
		 4 stuks	 2 stuks			 2 stuks
				Spandiepte mm	voor profiel mm	Bout-Ø x l mm
BAS...9-4						
Bestelnr.	3101428	3101431	3101726	-		-
Prijs	85,72 EUR	33,26 EUR	54,02 EUR			
BAS...10-6						
Bestelnr.	3101429	3101431	3101726	-		-
Prijs	91,85 EUR	33,26 EUR	54,02 EUR			
BSP...10-6						
Bestelnr.	3101430	-	3101726	-		-
Prijs	86,27 EUR		54,02 EUR			
BS2N / BS3N						5h11 x 26
Bestelnr.	-	-	-	-		3100747
Prijs						20,98 EUR
BS4N						5h11 x 26
Bestelnr.	-	-	-	-		3100748
Prijs						21,99 EUR
BSSN / BS6N SG-HS				140	30 x 15	
Bestelnr.	-	-	-	3101432		-
Prijs				107,71 EUR		

BESSEY Lijst van accessoires en reserveonderdelen 2024/2025

Corpuslijmtangen KR/KRV/KRE/KREV

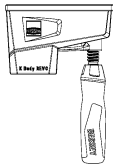
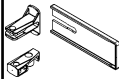
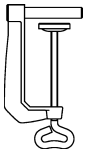
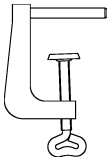
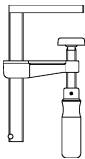
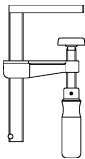
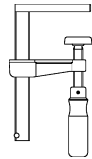
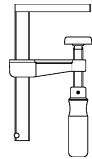
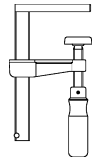
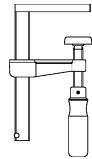
	Ondergedeelte compleet met glijbeugel	Set in zak	Tafelklem		Tafelklem		Tafelklem		Tafelklem	
		 3 beschermkap 2 steunen 1 eindzekering								
	Span- diepte mm	voor profiel mm	Span- diepte mm	Span- diepte mm	Span- diepte mm	Span- diepte mm	Span- diepte mm	Span- diepte mm	Span- diepte mm	Span- diepte mm
KR...-2K KRV...-2K KRE...-2K KREV...-2K	95	29 x 9	60	22	60	28	100	50	150	50
Bestelnr.	3101774	3101775	TK6		RB269		LM10/5R8		LM15/5R8	
Prijs	47,77 EUR	11,05 EUR	5,02 EUR		10,61 EUR		24,33 EUR		25,11 EUR	

Corpuslijmtangen K/KR/KRV/KRE/KREV

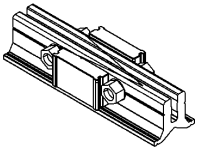
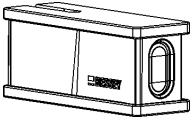
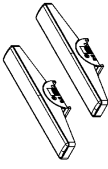
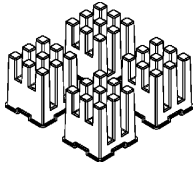
	Verlenging	Variabel bovendeel		Adapter, zwenkbaar		Frameperst
						
		Span- diepte mm	voor profiel mm	Bek- hoogte mm	Bek- breedte mm	
K...		95	29 x 9			
Bestelnr.	KBX20	KRE-VO		-		KP
Prijs	23,55 EUR	25,11 EUR				36,05 EUR
KR...-2K KRV...-2K KRE...-2K KREV...-2K		95	29 x 9	170	25	
Bestelnr.	KBX20	KRE-VO		KR-AS		KP
Prijs	23,55 EUR	25,11 EUR		16,63 EUR		36,05 EUR

Corpusspanner KS

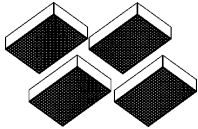
Drukstuk	
 <p>4 stuks /pak</p>	
KS	
Bestelnr.	3101845
Prijs	38,62 EUR

Vlakkenspanner FK

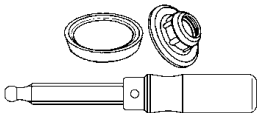
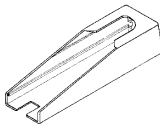

Spindel compleet met houten handgreep		Beschermkap
		 <p>2 stuks</p>
Trapeziumdraad mm		Spandiepte mm
FK16-8	-	80
Bestelnr.		3101790
Prijs		5,81 EUR
FK...-10	16 x 4	100
Bestelnr.	3101386	3101789
Prijs	13,50 EUR	6,36 EUR

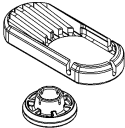
Schroefklem GearKlamp GK



Drukplaat + beschermkap in set	
 <p>5 paar</p>	
Ø mm	
GK	26
Bestelnr.	3101840
Prijs	9,71 EUR

BESSEY Lijst van accessoires en reserveonderdelen 2024/2025

Eénhandsklemmen EHZ / EZS

	Beschermkap-set	Beschermkap-set
		
	5 paar	10 stuks
	Ø mm	mm
EHZ...-2K		
Bestelnr.	3101402	-
Prijs	9,60 EUR	
EZS		40 x 48
Bestelnr.	-	3101841
Prijs		13,62 EUR



Eénhandsklemmen EZ

	Beschermkap-set	Klembevestiging
		
	10 stuks	2 stuks
EZM		
Bestelnr.	3101959	3101962
Prijs	8,48 EUR	12,05 EUR
EZL		
Bestelnr.	3101960	-
Prijs	10,27 EUR	
EZXL		
Bestelnr.	3101961	-
Prijs	15,18 EUR	

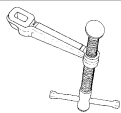
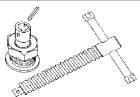
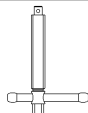
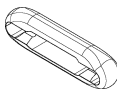

Eénhandsklemmen EZ360

	Beschermkap-set
	
	6 stuks
EZ360	
Bestelnr.	3102055
Prijs	12,00 EUR

Spantenlijmtang SPZ60K en SPZ80K

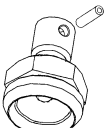

	Glijbeugel compleet	Combiset Spindel + speciale drukplaat + veerpin		Spindel		Knevelopzetstuk KA	Drukplaat met beschermkap
		 zonder zeskant		 met zeskant		 2 stuks	 4 paar
	voor profiel mm	Trapezium-draad mm	Knevel Ø x Lengte mm	Trapezium-draad mm	Knevel Ø x Lengte mm		
SPZ60K	27 x 13	18 x 5	10 x 120				
Bestelnr.	3101338	3100398		-		3101194*	3101188
Prijs	62,16 EUR	48,77 EUR				15,63 EUR	13,50 EUR
SPZ80K	30 x 15	20 x 5	11 x 120	20 x 5	11 x 120		
Bestelnr.	3101330	3100399		3101815		-	-
Prijs	78,80 EUR	53,58 EUR		29,02 EUR			

Spantenlijmtang SPZ80K

	Speciale drukplaat standaard		Speciale drukplaat gekarteld		Speciale drukplaat met prisma		Snijring	
								
	Spindelgat mm	Veerpen mm	Spindelgat mm	Veerpen mm	Spindelgat mm	Veerpen mm	Spindelgat mm	Veerpen mm
SPZ80K	12	5 x 20	12	5 x 20	12	5 x 20	12	5 x 20
Bestelnr.	3100736		3101192		3101193		3101219*	
Prijs	24,78 EUR		27,79 EUR		27,79 EUR		27,01 EUR	

BESSEY Lijst van accessoires en reserveonderdelen 2024/2025

Griptangen GRZ

	Beschermkap voor GRZ10 en GRZ20	Beschermkap voor GRZRO
	 4 stuks	 2 paar
GRZ 10 - GRZ 20		
Bestelnr.	3100576	-
Prijs	5,59 EUR	
GRZRO		
Bestelnr.	-	3101547
Prijs		6,92 EUR

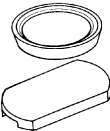

KliKlamp KLI

	Beschermkap voor bovenste en onderste deel	
	 10 paar	
	voor Ø mm	voor breedte onderste deel mm
KLI	25,5	23
Bestelnr.	3101393	
Prijs	15,51 EUR	

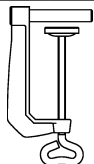
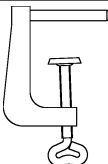
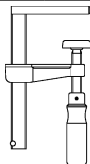
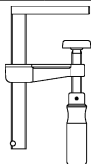
Schroefspanner S 10 / Hoekspanner WS

	Tafelklem		Tafelklem		Tafelklem		Tafelklem	
								
	Ø 8 mm		Ø 8 mm		Ø 8 mm		Ø 8 mm	
	Span- wijdte mm	Span- diepte mm	Span- wijdte mm	Span- diepte mm	Span- wijdte mm	Span- diepte mm	Span- wijdte mm	Span- diepte mm
S10-ST / WS 3	60	22	60	28	100	50	150	50
Bestelnr.	TK6		RB269		LM10/5R8		LM15/5R8	
Prijs	5,02 EUR		10,61 EUR		24,33 EUR		25,11 EUR	

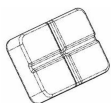
Eénhands tafelklem EZR

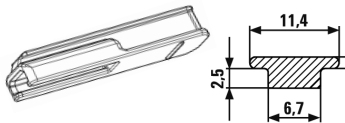
	Beschermkap-set	Klembevestiging	Adapter voor geleiderails (Bosch, Mafell)
			
	10 stuks	2 stuks	2 stuks
EZR			
Bestelnr.	3101959	3101962	3102016
Prijs	8,48 EUR	12,05 EUR	7,52 EUR

Geheel stalen tafelklem GTR

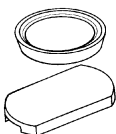
	Beschermkap voor bovenste en onderste deel	
		
	10 paar	
	voor Ø mm	voor breedte onderste deel mm
GTR	22	17
Bestelnr.	3101391	
Prijs	13,62 EUR	

BESSEY Lijst van accessoires en reserveonderdelen 2024/2025

Bandspanner BAN

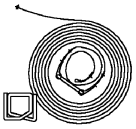
Band reserveonderdeel/verlenging	
	
BAN 700 / SVH	Band 7100 mm, 2 spangespen
Bestelnr.	3100832
Prijs	19,53 EUR

Eénhands-kantenlijmtang EKT

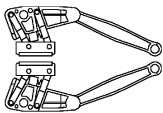
	Reservezet	Bekken compleet met koppelstang
		
	3 stuks beschermkappen en 6 stuks drukkoppen	2 paar
EKT55		
Bestelnr.	3101403	3100998
Prijs	25,22 EUR	28,80 EUR

Kantenlijmtang KT

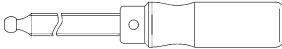
Spindel compleet	
	
KTS-1	
Bestelnr.	3101799
Prijs	7,03 EUR

Kantenfix KF en platendrager KFP

Drukbekken	
	
1 paar incl. veer	
KF2	
Bestelnr.	4102100
Prijs	42,72 EUR
KF4	
Bestelnr.	4102056
Prijs	46,95 EUR
KFP	
Bestelnr.	4102057*
Prijs	50,00 EUR

* geschikt voor KFP vanaf 2018 (rode drubbekken)

Platenspanner PS

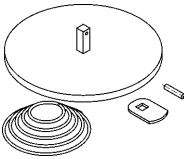
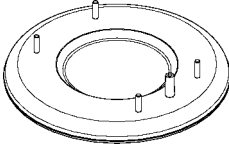
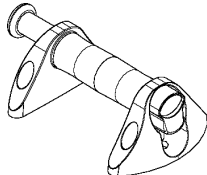



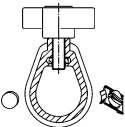

	Zuigkleem	Rubberplaat	Greep
			
	Ø mm	Ø mm	
PS 55	120		
Bestelnr.	3101839	-	-
Prijs	58,26 EUR		
PS 130		210	
Bestelnr.	-	3101685	3101686
Prijs		83,60 EUR	89,17 EUR

BESSEY Lijst van accessoires en reserveonderdelen 2024/2025

Kozijnspanner TMS

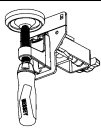
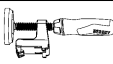
	Klemstuk
	
TMS	
Bestelnr.	3100983
Prijs	5,14 EUR

Kozijnspanner TU

	Drukplaat met binnenbuis en klemstuk compleet	Drukplaat met buitenbuis en klemstuk compleet	Spanbeugel breed compleet incl. schuifdeel	Spanklem compleet	Verlenging	Viltstrepen	TU tas
						 4 stuks	
		Binnenmaat mm					
TU		25 x 25					
Bestelnr.	3100934	3100935	3101752	3101764	TUX	3101632	3101762
Prijs	32,36 EUR	35,49 EUR	29,58 EUR	14,84 EUR	33,48 EUR	7,48 EUR	92,41 EUR

Kozijnuitlijnklem TFM

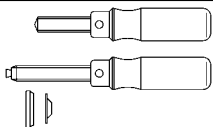
	2 x Spindel met drukplaat en beschermkap
	
TFM	
Bestelnr.	3101408
Prijs	20,31 EUR

Vensteruitlijnklem FRK

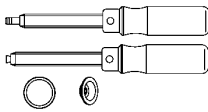
	2 x Spindel met drukplaat en beschermkap
	
FRK	
Bestelnr.	3101409
Prijs	20,31 EUR

Deurenspanner TAN

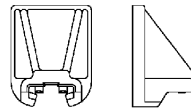
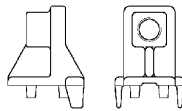
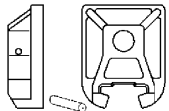
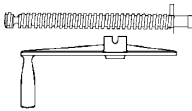
	Drukbecken		Spindelhouder	Spanbecken	Spindelset TAN
					
	Bekbreedte mm	Bekhoogte mm	Trapezium- draad mm		
TAN	75	80	20 x 5		
Bestelnr.	3101791*		3101824*	3100919*	3101404*
Prijs	46,99 EUR		42,19 EUR	58,26 EUR	42,63 EUR

Deurenspanner TB

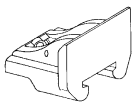
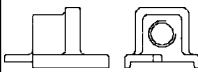
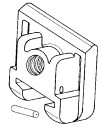
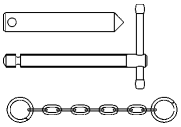

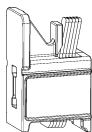

	Drukbecken		Spindelhouder	Spanbecken	Spindelset TB
					
	Bekbreedte mm	Bekhoogte mm	Trapezium- draad mm		
TB	60 (80)	48	18 x 5		
Bestelnr.	3101793		3101792	3100920	3101405
Prijs	33,26 EUR		32,81 EUR	36,28 EUR	23,55 EUR

BESSEY Lijst van accessoires en reserveonderdelen 2024/2025



Deurenspanner TL

Drukbekken compleet	
	
TL	
Bestelnr.	3101877
Prijs	25,11 EUR

Plafond- en montagesteunen STE, ST



	Multifunctionele-/ laserhouder	Steunplaat	Plafondstempel	Bouwstempel	Combitas
					
STE					
Bestelnr.	STE-LH	STE-SP35	STE-DS	STE-BS	-
Prijs	19,42 EUR	16,97 EUR	21,43 EUR	55,69 EUR	-
ST					
Bestelnr.	STE-LH	STE-SP35	STE-DS	STE-BS	-
Prijs	19,42 EUR	16,97 EUR	21,43 EUR	55,69 EUR	-
STE300 STE370					
Bestelnr.	-	-	-	-	STE-BAG
Prijs	-	-	-	-	77,01 EUR

Plafond- en montagesteunen STE, ST

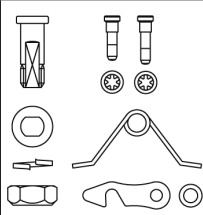
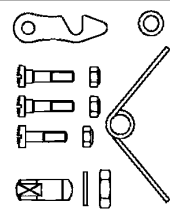
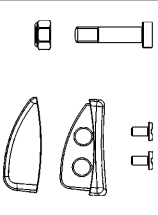

	Contactvlak vervangingsonderdeel	Vergrendelingslip	Stergreepschroef
			 4 stuks
STE			
Bestelnr.	3101952	-	-
Prijs	12,05 EUR		
ST			
Bestelnr.	3101952	3101969	-
Prijs	12,05 EUR	9,37 EUR	
STE-SP35			
Bestelnr.	-	-	3101970
Prijs			7,03 EUR

BESSEY Lijst van accessoires en reserveonderdelen 2024/2025

Blikscharen met hefboomoverbrenging

	Reparatieset 08/22A 27/29/123S	Reparatieset 17A-2	Laaghouder compleet 123S	Roltas
				 voor 3 scharen
D08 ... D16A D22A D27AH-TIN/L				
Bestelnr.	R032	-	-	7002464
Prijs	7,59 EUR			9,94 EUR
D16 / D16L / D16S				
Bestelnr.	-	-	-	7002464
Prijs				9,94 EUR
D27 ... D29 ...				
Bestelnr.	R001	-	-	7002464
Prijs	7,59 EUR			9,94 EUR
D17A-2/L				
Bestelnr.	-	R043	-	7002464
Prijs		7,70 EUR		9,94 EUR
D123S				
Bestelnr.	R001	-	R042	7002464
Prijs	7,59 EUR		14,84 EUR	9,94 EUR

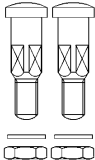
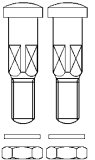
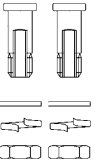
Standaard blikscharen

	Verschroefing compleet M6 D8 x 24	Verschroefing compleet M6 D8 x 26	Verschroefing compleet M8 x1 x 22	Roltas
	 <p>2 stuks</p>	 <p>2 stuks</p>	 <p>2 stuks</p>	 <p>voor 3 scharen</p>
D101-200 – D101-250 D201-200 – D201-250 D102-225 D202-225 D107-225 – D107-275 D207-225 – D207-275 D114-250 – D114-275 D214-250 – D214-275 D159-200 – D159-250				
Bestelnr. Prijs	R034 6,47 EUR	-	-	7002464 9,94 EUR
D102-250 – D102-300 D202-250 – D202-300 D106-250 D106A-250 D107-300 – D107-350 D207-300 – D207-350 D208-275 D209-275 D114-300 D214-300 D159-300 – D159-350				
Bestelnr. Prijs	-	R035 6,47 EUR	-	7002464 9,94 EUR
D116-260 – D116-280 D216-260 – D216-280 D216-260-B-SBSK D216-280-B-SBSK D118-300 – D118-350 D218-300 – D218-350 D416-280 D 418-300 – D418-350				
Bestelnr. Prijs	-	-	R036 6,47 EUR	7002464 9,94 EUR
D407-275 – D407-300				
Bestelnr. Prijs	-	-	-	7002464 9,94 EUR

BESSEY Lijst van accessoires en reserveonderdelen 2024/2025



Knipmessen

	Stanleymessen	Tapijtmessen	Uitsnijmessen
			
	10 stuks	10 stuks	5 stuks
DBKPH DBKWH DBKAH			
Bestelnr.	DBK-T	DBK-H	DBK-L
Prijs	4,35 EUR	7,03 EUR	7,59 EUR

BESSEY
Imagefilm



BESSEY Tool GmbH & Co. KG ■ Mühlwiesenstraße 40
74321 Bietigheim-Bissingen, Germany
Fon +49 7142 401-0 ■ Fax: +49 7142 401-452
E-Mail: tool-info@bessey.de

Uw dealer:

Meer informatie op
www.bessey.de

